



JIMY

SURGICAL INSTRUMENTS



PRODUCTS CATALOGUE

Diagnostics



Buck
JU-1-102-18
20cm,



Buck
JU-1-101-18
Percussion Hammer
18.5 cm,

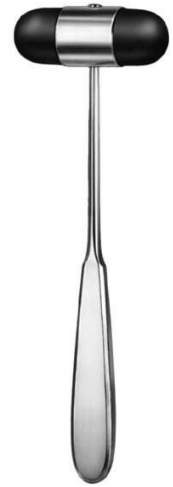

Dejerine
JU-1-103-20
Percussion Hammer
20cm,



Dejerine
JU-1-104-21
Percussion Hammer
21cm,



Taylor Mod. USA
JU-1-105-20
Percussion Hammer
20cm,



Wartenberg
JU-1-106-19
Pinwheel
18cm,



Pinard
JU-1-107-18
Stethoscope
18 cm,



Pinard
JU-1-108-15
Stethoscope
15cm,

Anesthesia

Magill
JU-2-101-15
 Catheter Introducing Forceps
 14.5 cm, 20 cm, 25 cm,



Miller
JU-2-102-00
 Laryngoscope Sets



Millar-Baby
JU-2-103-00
 Laryngoscope Sets



Miller
JU-2-104-00
 Laryngoscope Blade
 Fig. 0, Fig. 1, Fig. 2, Fig. 3, Fig. 4,



Guedel-Negus
JU-2-105-00
 Laryngoscope Sets
 Fig. 2, Fig. 3, Fig. 4,



Guedel-Negus
JU-2-106-00
 Laryngoscope Sets
 Fig. 1, Fig. 2, Fig. 3, Fig. 4,



Guedel-Negus
JU-2-107-01

Laryngoscope Blades
Fig. 1, Fig. 2, Fig. 3, Fig. 4,



McIntosh
JU-2-108-00



McIntosh
JU-2-109-00
Laryngoscope Blades
Fig. 0, Fig. 1, Fig. 2, Fig. 3, Fig. 4,



McIntosh
JU-2-110-00

Laryngoscope Sets
Fig. 1, Fig. 2, Fig. 3, Fig. 4,



Foregger
JU-2-111-01
Laryngoscope Blades
Fig. 1, Fig. 2, Fig. 3, Fig. 4,



Battery Handle
JU-2-112-00
Battery Handle



**McIntosh
JU-2-114-00**

Laryngoscope Sets fiber optic
Fig. 1, Fig. 2, Fig. 3,



**McIntosh
JU-2-115-00**

Laryngoscope Sets fiber optic
Fig. 1, Fig. 2, Fig. 3,



**McIntosh
JU-2-116-00**

Laryngoscope Sets fiber optic
Fig. 1, Fig. 2, Fig. 3,



**McIntosh
JU-2-113-00**

Laryngoscope Sets
Fig. 1, Fig. 2, Fig. 3, Fig. 4,

Trocars

Universal
JU-3-101-04
Trocar
14 cm,



Nelson
JU-3-102-07
Trocar
20 cm,



Lichtwitz
JU-3-103-19
Antrum Trocar
18.5 cm,



Adson
JU-3-104-21
Suction Cannula
20 cm,



Frazier
JU-3-105-10
Suction Cannula
24 cm,



Frazier
JU-3-106-06
Suction Cannula
19.5 cm,

Trocars

Poppen
JU-3-107-06
 Suction Cannula
 18 cm,



Luer
JU-3-108-30
 Suction Tube working length 110 mm



Yasargil
JU-3-109-15
 Suction Tube working length 150 mm with
 Luer hub
 21.5 cm,



Yankauer
JU-3-110-27
 Suction Tube complete with suction tip and
 connector
 31 cm,



Yankauer
JU-3-111-00
 Suction Tube
 31 cm, 15 cm, 2.5 cm, 10 cm,



Poole
JU-3-112-22
 Suction Tube
 22 cm,

Trocars



Poole
JU-3-113-22
Suction Tube
22.5 cm,



Nuboer
JU-3-114-21
Suction Tube
21 cm,



Nuboer
JU-3-115-21
Suction Tube
21 cm,



Quinke
JU-3-116-10
Lumbar Puncture Needle



Tuohy
JU-3-117-12
Lumbar Puncture Needle Luer Lock
connection with special tip



Verres
JU-3-118-20
Insufflation Cannula Luer Lock connection
15 cm,



Verres

JU-3-119-20

Insufflation Cannula Luer Lock connection
17 cm,

Suture

Kalt
JU-4-105-14
 Needle Holder
 13.5 cm,



Barraquer-Troutman
JU-4-106-10
 Micro Needle Holder
 10 cm, 10.5 cm,



Arruga
JU-4-107-14
 Micro Needle Holder
 13.5 cm,



Barraquer-Troutman
JU-4-108-10
 Micro Needle Holder
 10.5 cm, 11.5 cm,



Barraquer
JU-4-109-11
 Micro Needle Holder
 11.5 cm, 13.5 cm, 14 cm,

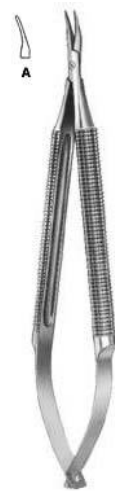

Barraquer
JU-4-110-13
 Micro Needle Holder
 13.5 cm,



Castroviejo-Fino
JU-4-111-01
 Micro Needle Holder
 13 cm,



Castroviejo-Fino
JU-4-112-01
 Micro Needle Holder
 13 cm,



Castroviejo-Fino
JU-4-113-01
 very delicate jaw with lock
 13 cm,



Castroviejo
JU-4-114-14
 Micro Needle Holder with lock
 14 cm,



Castroviejo
JU-4-115-14
 Micro Needle Holder
 14 cm,



Castroviejo
JU-4-121-14
 Micro Needle Holder with lock
 14 cm,

Suture

Castroviejo
JU-4-122-14
 Micro Needle Holder
 14 cm,



Castroviejo
JU-4-124-13
 Micro Needle Holder with lock
 12 cm,



Arruga
JU-4-123-16
 Needle Holder delicate
 16 cm,



Castroviejo
JU-4-125-12
 Micro Needle Holder with lock
 12 cm,



Derf
JU-4-126-12
 Needle Holder
 12 cm, 13 cm,

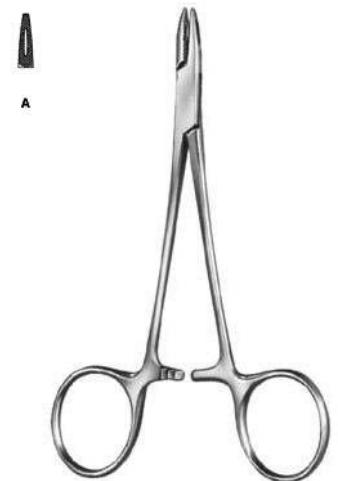

Collier
JU-4-127-12
 Needle Holder
 12.5 cm,

Suture

Webster
JU-4-128-13
 Needle Holder
 13 cm,



Halsey
JU-4-129-13
 Needle Holder
 13.5 cm,



Neivert
JU-4-130-13
 Needle Holder
 12.5 cm,



Hegar-Baumgartner
JU-4-131-14
 Needle Holder
 14.5 cm,



Crile-Murray
JU-4-133-15
 Needle Holder
 15 cm,



Crile-Wood
JU-4-134-15
 Needle Holder
 15 cm,

Adson
JU-4-140-18

 Needle Holder one fenestrated jaw
18 cm,

Metzenbaum
JU-4-141-18

 Needle Holder one grooved and fenestrated
jaw
18.5 cm,

M. G. Hospital
JU-4-142-17

 Needle Holder
17.5 cm,

Mayo-Hegar
JU-4-143-14

Needle Holder

 14.5 cm, 16 cm, 18.5 cm, 20.5 cm, 24 cm, 26.5
cm,

Mayo-Hegar
JU-4-144-16

Needle Holder

16 cm, 18.5 cm, 20.5 cm,



Brown
JU-4-145-13

Needle Holder

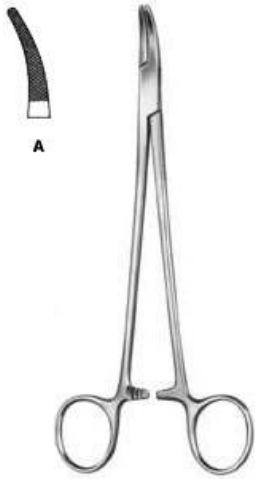
13 cm, 18 cm,

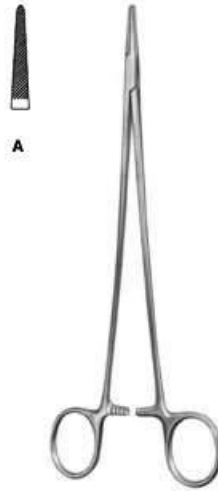

Heaney
JU-4-146-21
 Needle Holder
 20.5 cm,



Jamison
JU-4-147-23
 Needle Holder
 23.5 cm,



Masson
JU-4-148-27
 Needle Holder
 26.5 cm,



Finochietto
JU-4-149-27
 Needle Holder
 26.5 cm,



Wangensteen
JU-4-150-27
 Needle Holder
 26.5 cm,

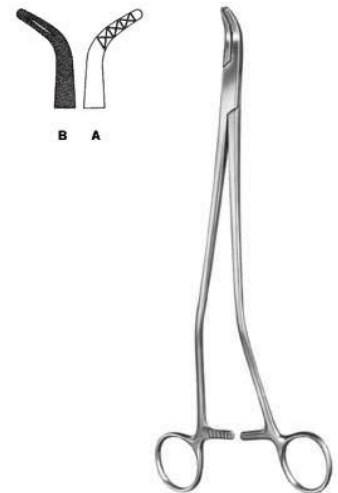

Johnson
JU-4-151-27
 Needle Holder
 27 cm,

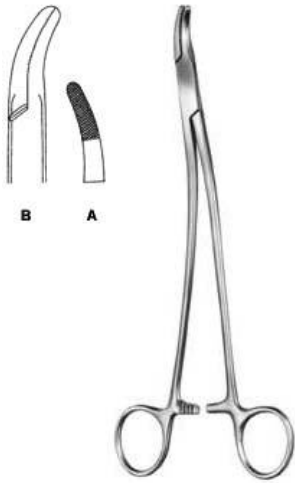

Stratte
JU-4-152-23
 Needle Holder
 23 cm,

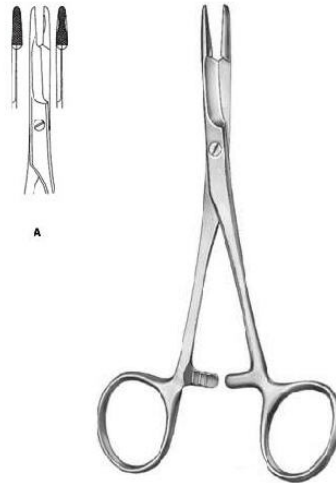

Olsen-Hegar
JU-4-153-14
 Needle Holder
 14 cm,

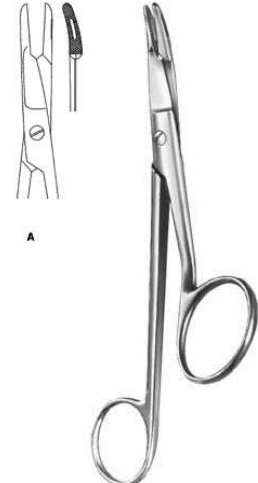

Gillies
JU-4-154-16
 Needle Holder
 16 cm,



Crile
JU-4-155-15
 Needle Holder
 15 cm,



Mathieu
JU-4-156-14
 Needle Holder
 14 cm, 17 cm, 20 cm,



Mathieu
JU-4-157-14
 Needle Holder
 14 cm, 16.5 cm,



Toennis
JU-4-158-18
 Needle Holder
 18.5 cm,



Lichtenberg
JU-4-159-20
 Needle Holder
 20 cm,



JU-4-160-16
 Micro Needle Holder
 16 cm,

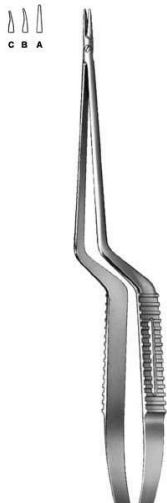

JU-4-161
 Micro Needle Holder
 23 cm, 19 cm,



Hepp-Scheidel
JU-4-162-18
 Micro Needle Holder smooth jaw
 18 cm,

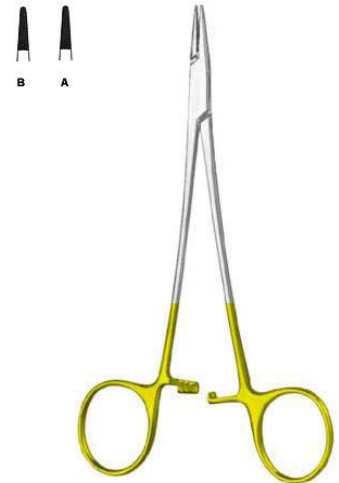

Webster
JU-4-163-13
 Needle Holder with automatic release ratchet
 also for lefthanders
 13 cm, 15 cm,

Suture

JU-4-164-15

Micro Needle Holder
15 cm, 18 cm, 21 cm, 23 cm,

JABOMA
JU-4-165-18

Micro Needle Holder
18 cm,

Castroviejo
JU-4-166

Micro Needle Holder
14.5 cm, 18 cm, 21.5 cm,

Arruga
JU-4-167

Needle Holder
16 cm,

Castroviejo
JU-4-168-13

Micro Needle Holder
12.5 cm,

Barraquer
JU-4-169-13

Micro Needle Holder
13 cm,



Barraquer
JU-4-170-13
 Micro Needle Holder
 13 cm,



Webster
JU-4-171-13
 Needle Holder
 13 cm,



Derf
JU-4-173-12
 Needle Holder
 12 cm,

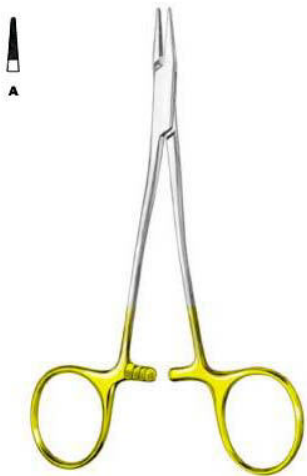

Kilner
JU-4-172-13
 Needle Holder
 13 cm,



Hegar-Baumgartner
JU-4-174-13
 Needle Holder
 13 cm, 14.5 cm,



Halsey
JU-4-175-12
 Needle Holder
 13 cm, 12 cm,

Suture

Crile-Wood
JU-4-176-15
 Needle Holder
 15 cm,



Sartot
JU-4-177-18
 Needle Holder
 18 cm, 20 cm, 26 cm,

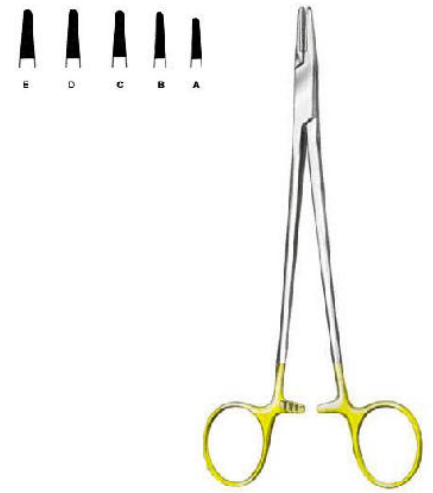

Mayo-Hegar
JU-4-178-16
 Needle Holder standard profile
 16 cm, 18 cm, 20 cm, 24 cm, 26 cm, 30 cm,



Heaney
JU-4-179-20
 Needle Holder
 20 cm, 24 cm, 26 cm,



DeBakey
JU-4-180-18
 Needle Holder delicate pattern mini profile
 18 cm, 20 cm, 23 cm, 26 cm, 31 cm,



Masson
JU-4-181-27
 Needle Holder
 26.5 cm,

Suture

Ryder (Martin)
JU-4-182-13

Needle Holder

12.5 cm, 15 cm, 18 cm, 20 cm, 23 cm, 26 cm,

Martin
JU-4-183-15

Needle Holder mini profile elastic type

15 cm, 17 cm, 20 cm,

Wangensteen
JU-4-184-27

Needle Holder standard profile

27 cm,

Hegar-Vascular
JU-4-185-14

Needle Holder micro profile

14 cm, 18.5 cm, 20.5 cm, 23 cm,

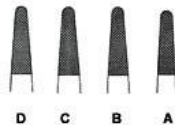
Bozemann
JU-4-186-20

Needle Holder standard profile

20.5 cm, 24 cm, 26.5 cm, 29 cm,

Hegar
JU-4-187-20

Needle Holder standard profile

20 cm, 23.5 cm,

Suture

Stratte
JU-4-188-22

 Needle Holder standard profile
23 cm,

Microvascular
JU-4-189-00

 Needle Holder slender pattern micro profile
14 cm, 17.5 cm, 20 cm, 23 cm,

Mathieu
JU-4-190-14

 Needle Holder
14 cm, 17 cm, 20 cm,

Mathieu
JU-4-191-14

 Needle Holder
14 cm, 17 cm, 20 cm,

Mathieu
JU-4-192-17

 Needle Holder standard profile with interior
ratchet
17 cm, 20 cm, 23 cm,

Toennis
JU-4-193-18

 Needle Holder
18.5 cm,



Lichtenberg
JU-4-194-20

Needle Holder lightweight model standard profile
20 cm,



Langenbeck
JU-4-195-18

Needle Holder
18 cm, 20.5 cm, 23 cm,



Zweifel
JU-4-196-20

Needle Holder with hinged ratchet standard profile
20.5 cm, 23 cm,



Reverdin
JU-4-197-15

Reverdin Needle short
14.5 cm Fig. 1, 14.5 cm Fig. 2, 14.5 cm Fig. 3, 14.5 cm Fig. 4,

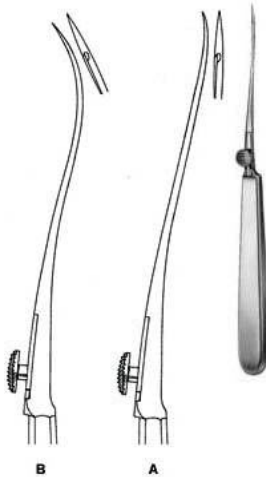

Reverdin
JU-4-198-19

Reverdin Needle medium
19.5 cm Fig. 1, 19.5 cm Fig. 2, 19.5 cm Fig. 3, 19.5 cm Fig. 4,

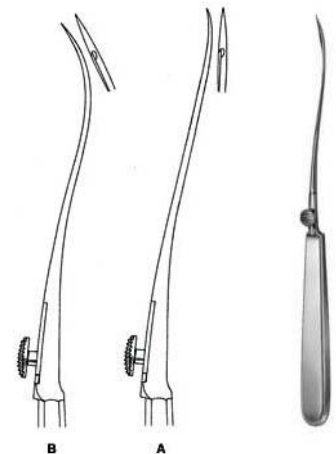

Reverdin
JU-4-199-23

Reverdin Needle long
23 cm Fig. 1, 23 cm Fig. 2, 23 cm Fig. 3, 23 cm Fig. 4,

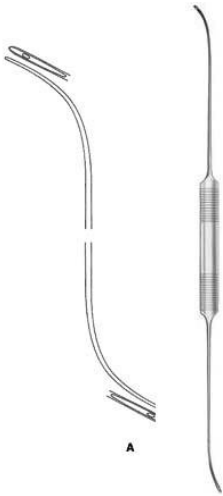
Suture

Schmieden-Dick
JU-4-201-01
 Ligature Needle malleable
 29 cm,

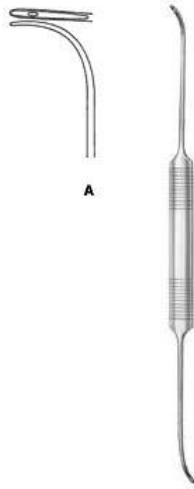

Schmieden
JU-4-202-21
 Ligature Needle
 24 cm,



JU-4-203-20
 Ligature Needle malleable
 20.5 cm,

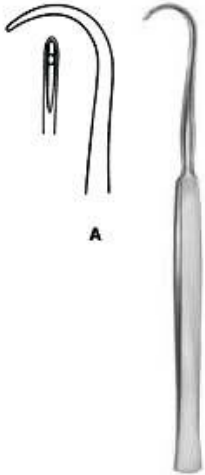

Cooper
JU-4-204-19
 Ligature Needle
 18.5 cm,



Kronecker
JU-4-205-13
 Ligature Needle delicate for right hand
 12.5 cm,

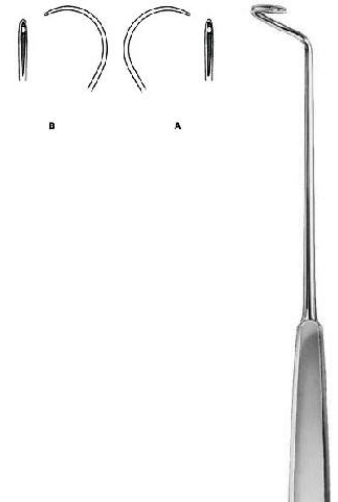

Deschamps
JU-4-206-24
 Ligature Needle blunt for right hand
 24 cm,

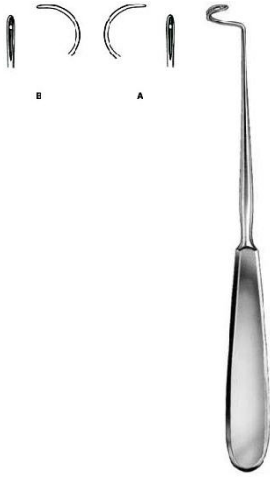
Suture

Deschamps
JU-4-207-20
 Ligature Needle blunt for right hand
 20 cm,



Deschamps
JU-4-208-20
 Ligature Needle sharp for right hand
 20 cm,

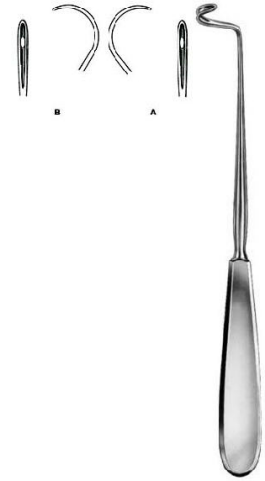

Deschamps
JU-4-209-21
 Ligature Needle blunt for right hand
 20 cm,

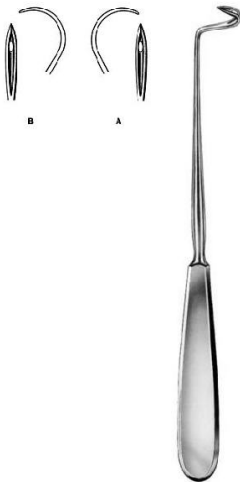

Deschamps
JU-4-210-21
 Ligature Needle sharp for right hand
 20 cm,

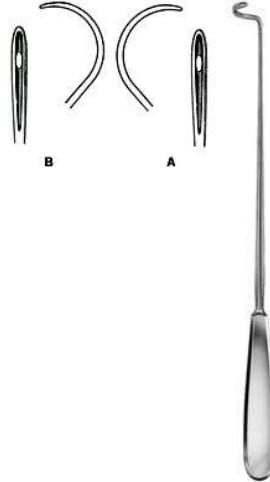

Deschamps
JU-4-211-27
 Ligature Needle blunt for right hand
 27 cm,

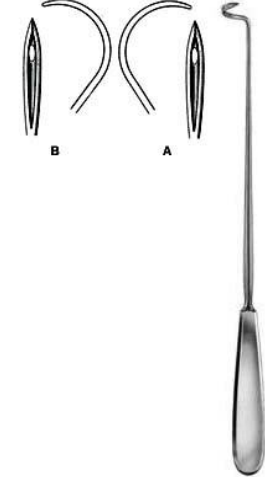

Deschamps
JU-4-212-27
 Ligature Needle sharp for right hand
 27 cm,

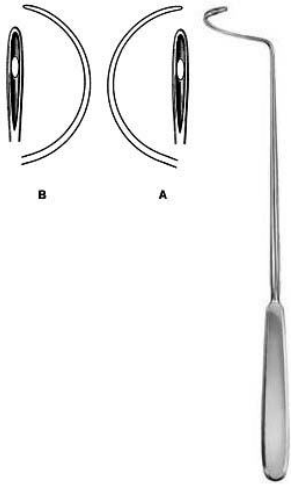
Suture

Deschamps
JU-4-213-28

Ligature Needle blunt for right hand
28 cm,

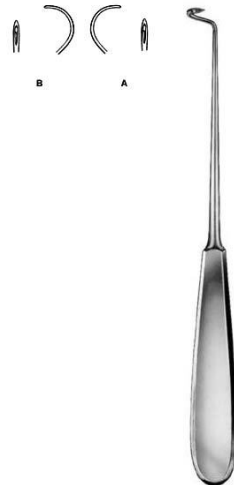

Deschamps
JU-4-214-20

Ligature Needle sharp for right hand
20 cm,



Deschamps
JU-4-215-20

Ligature Needle blunt for right hand
20 cm,



Deschamps
JU-4-216-20

Ligature Needle blunt for right hand
21 cm,

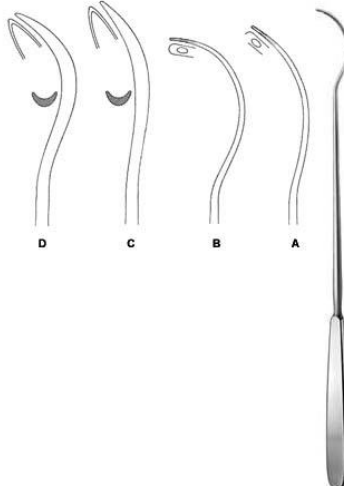

Brunner
JU-4-217-30

Ligature Needle
21 cm,

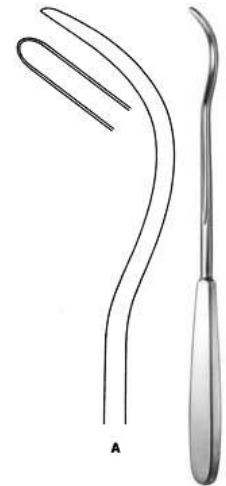

Kirschner
JU-4-218-25

Ligature Conductor
25.5 cm,

Suture

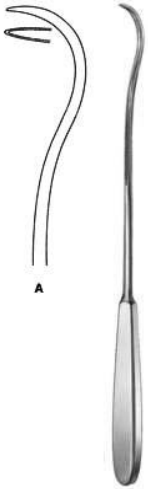

JU-4-219-28
Ligature Conductor
28 cm,



Modell Wien
JU-4-220-23
Ligature Catcher
23.5 cm,



Michel
JU-4-221-12
Clip Applying Forceps
12 cm,



Hegenbarth
JU-4-222-12
Clip Applying Forceps
12 cm,

Scalpels

JU-5-101-01

Dissecting Knife with metal handle
15 cm, 15.5 cm, 16 cm, 17 cm,

JU-5-102-10

Autopsy Knife
25.5 cm,

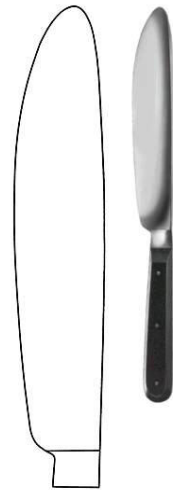
Walb
JU-5-104-17

Post Mortem Knife

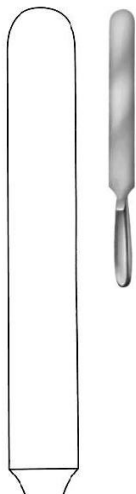
Virchow
JU-5-105-20

Brain Knife with hollow handle
28.5 cm, 33.5 cm, 38 cm,

JU-5-108-04

Scalpel Handle solid
13.5 cm,

JU-5-109-34

Scalpel Handle
16 cm,

Scalpels

JU-5-110-41

Scalpel Handle solid, long
21 cm,

JU-5-111-45

Scalpel Handle
21 cm,

Collin
JU-5-112-08

Scalpel Handle with hollow handle
13.5 cm,

Collin
JU-5-113-09

Scalpel Handle with hollow handle
14.5 cm,

JU-5-114-03

Scalpel Handle solid
12 cm,

JU-5-115-04

Scalpel Handle
12 cm,

Scalpels

JU-5-116-05
Scalpel Handle
12 cm,



JU-5-117-31
Scalpel Handle solid, long
21.5 cm,



JU-5-118-35
Scalpel Handle
21 cm,



JU-5-119-07
Scalpel Handle solid
16 cm,



JU-5-120-71
Scalpel Handle solid short
12.5 cm,



JU-5-121-03
Scalpel Handle with round hollow handle
15.5 cm,

Scalpels

JU-5-127-16

Amputation Knife with hollow handle
29 cm,

JU-5-128-19

Amputation Knife with hollow handle
32.5 cm,

Catlin
JU-5-129-16

Interosseous Knife with hollow handle
29cm,

JU-5-130-06

Resection Knife solid handle, dissecting end
18 cm,

Langenbeck
JU-5-131-05

Resection Knife
18 cm,

Langenbeck
JU-5-132-05

Resection Knife
18 cm,

Scalpels



JU-5-133-00

Razor Knife hollow blades on both sides cutting length 75mm



Schink

JU-5-134-00

Dermatome complete with 2 skin fixing plates and one blade 31 cm,



Schink

JU-5-135-01

Spare Blade spare blade for KE-05-134-00



Schink

JU-5-136-02

Skin Fixing Plate for KE-05-134-00

Scissors

Standard BL / BL Straight
JU-5-201-13

Operating Scissor Special Price: \$1.25

12 cm, 13 cm, 14.5 cm, 16.5 cm, 18.5 cm, 20.5 cm,

Standard SH / BL STR
JU-5-202-13

Operating Scissors

12 cm, 13 cm, 14.5 cm, 16.5 cm, 18.5 cm, 20.5 cm,

Standard SH / SH STR
JU-5-204-13

Operating Scissors

12 cm, 13 cm, 14.5 cm, 16.5 cm,

Standard BL / BL Curved
JU-5-205-13

Operating Scissors

12 cm, 13 cm, 14.5 cm, 16.5 cm, 18.5 cm, 20.5 cm,

Standard SH / BL Curved
JU-5-206-13

Operating Scissors

12 cm, 13 cm, 14.5 cm, 16.5 cm, 18.5 cm, 20.5 cm,

Standard SH / SH Curved
JU-5-207-13

Operating Scissors

12 cm, 13 cm, 14.5 cm, 16.5 cm,

Scissors

Standard BL / BL Curved
JU-5-208-14
 Operating Scissors delicate
 14.5 cm,



Incision Scissor
JU-5-209-14
 Operating Scissor
 14.5 cm,



Deaver
JU-5-210-14
 Operating Scissors



Mayo
JU-5-211-15
 Dissecting Scissors
 14.5 cm, 15 cm, 17 cm, 23.5 cm, 14.5 cm, 15
 cm, 17 cm, 23.5 cm,



Mayo
JU-5-212-23
 Dissecting Scissors
 23 cm, 22.5 cm, 28 cm,

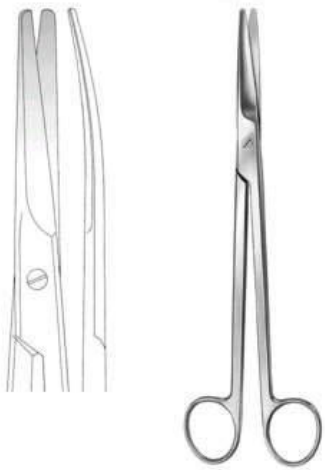

Mayo-Harrington
JU-5-213-22
 Dissecting Scissors
 23 cm, 22.5 cm, 28 cm,

Scissors

Mayo-Harrington
JU-5-214-22
 Dissecting Scissors cur.
 22.5 cm, 28 cm, 23 cm,

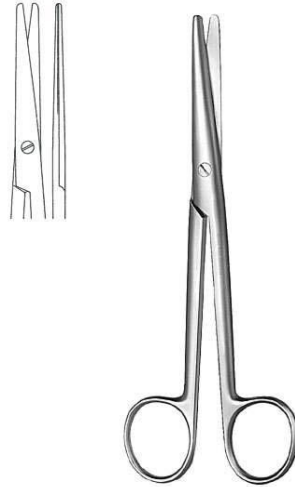

Mayo-Stille
JU-5-215-17
 Dissecting Scissors str.
 15 cm, 17 cm,

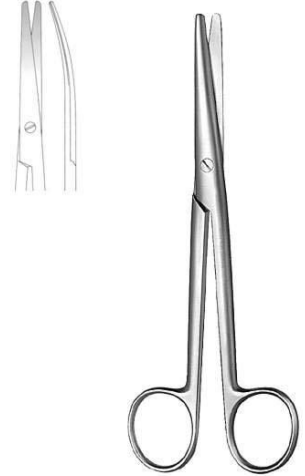

Mayo-Stille
JU-5-216-15
 Dissecting Scissors cur.
 15 cm, 17 cm,

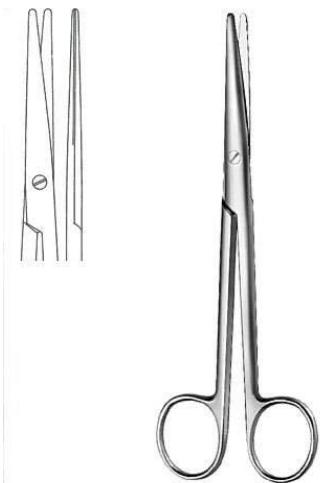

Mayo-Stille
JU-5-217-19
 Dissecting Scissors str.
 16 cm, 19.5 cm, 21.5 cm,

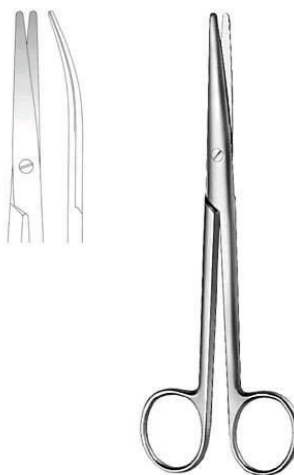

Mayo-Stille
JU-5-218-16
 Dissecting Scissors cur.
 16 cm, 19.5 cm, 21.5 cm,



Mayo-Noble
JU-5-219-17
 Gynecological Scissors
 16.5 cm,

Scissors

Sims
JU-5-220-23

 Gynecological Scissors str.
20 cm, 23 cm,

Sims
JU-5-221-20

 Gynecological Scissors cur.
20 cm, 23 cm,

Kelly
JU-5-222-16

 Operating Scissors
16 cm,

Doyen
JU-5-223-17

 Gynecological Scissors
18.5 cm,

Sims-Siebold
JU-5-224-24

 Gynecological Scissors
24.5 cm,

Sims-Siebold
JU-5-225-24

 Gynecological Scissors
24.5 cm,

Scissors

Wertheim
JU-5-226-23
 Gynecological Scissors
 20 cm, 23 cm,



Metzenbaum
JU-5-227-11
 Dissecting Scissors
 11.5 cm,



Metzenbaum
JU-5-228-14
 Dissecting Scissors
 14.5 cm,



Metzenbaum
JU-5-229-15
 Dissecting Scissors
 15.5 cm,



Metzenbaum-Nelson
JU-5-230-20
 Dissecting Scissors
 18 cm, 20.5 cm, 23 cm, 26 cm, 28.5 cm, 31 cm,



Metzenbaum-Nelson
JU-5-231-20
 Dissecting Scissors
 18 cm, 20.5 cm,

Scissors

Metzenbaum-Nelson
JU-5-232-20

Dissecting Scissors
18 cm, 20.5 cm, 23 cm, 26 cm, 28.5 cm, 31 cm,



Metzenbaum
JU-5-233-14

Dissecting Scissors toothed
14.5 cm,



Nerve Operating Scissor
JU-5-234-15

Dissecting Scissors
15.5 cm,



Gorney
JU-5-235-19

Face-lift Scissors str.
12.5 cm, 19.5 cm,

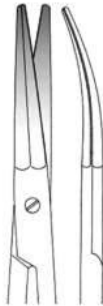

Gorney
JU-5-236-19

Face-lift Scissors cur.
19.5 cm,



Aston
JU-5-237-17

Face-lift Scissors
17 cm,

Scissors

Lexer
JU-5-238-16
 Dissecting Scissors
 16 cm,



Cinelli
JU-5-239-14
 Nasal Scissors
 11.5 cm, 14 cm,



Thorek
JU-5-240-19
 Dissecting Scissors
 18.5 cm,



Lexer-Baby
JU-5-241-10
 Dissecting Scissors
 10 cm,



Lexer-Fino
JU-5-242-16
 Delicate Dissecting Scissors slender pattern
 16.5 cm,



Metzenbaum-Fino
JU-5-243-14
 Delicate Dissecting Scissors slender pattern
 14.5 cm,

Scissors



Metzenbaum-Fino
JU-5-244-14
 Delicate Dissecting Scissors
 14.5 cm,



Metzenbaum-Fino
JU-5-245-14
 Delicate Dissecting Scissors
 14.5 cm,

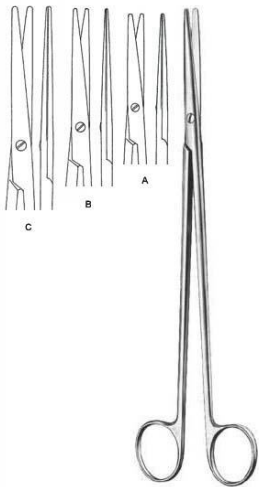

Metzenbaum-Fino
JU-5-246-14
 Delicate Dissecting Scissors
 14.5 cm,



Metzenbaum-Fino
JU-5-247-18
 Delicate Dissecting Scissors slender pattern
 18 cm, 20 cm, 23 cm,

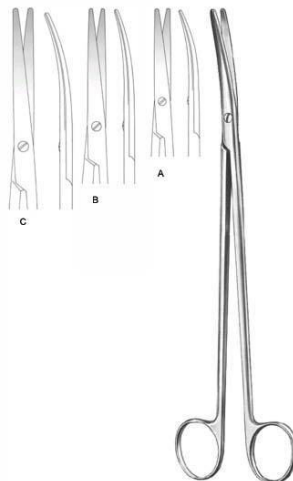

Metzenbaum-Fino
JU-5-248-18
 Delicate Dissecting Scissors slender pattern
 18 cm, 20 cm, 23 cm,

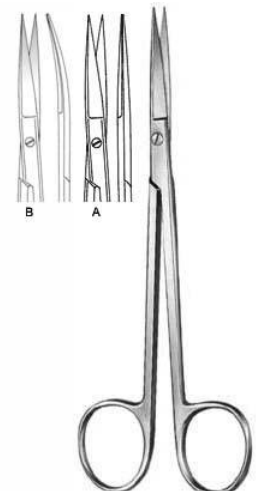

Sanvenero
JU-5-250-14
 Operating Scissors
 14 cm,

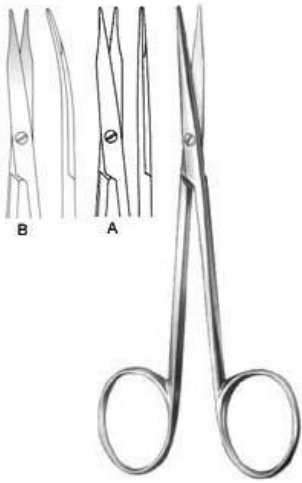
Scissors

JU-5-251-11
Fine Operating Scissors
11.5 cm,

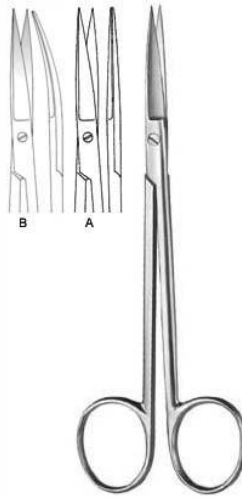

Joseph
JU-5-252-14
Operating Scissors
14.5 cm,

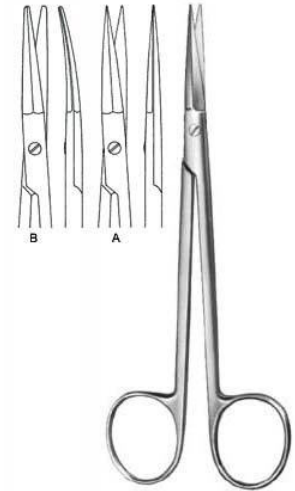

Peck-Joseph
JU-5-253-14
Face-lift Scissors
14.5 cm,

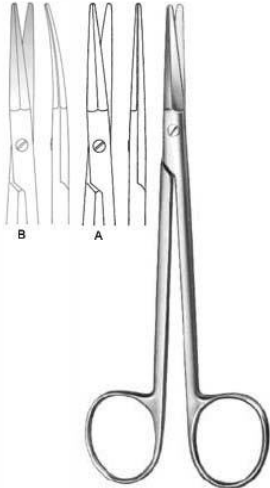

Peck-Joseph
JU-5-254-14
Face-lift Scissors
14.5 cm,



Shea Vein Graft
JU-5-255-12
Dissecting Scissors
12 cm,

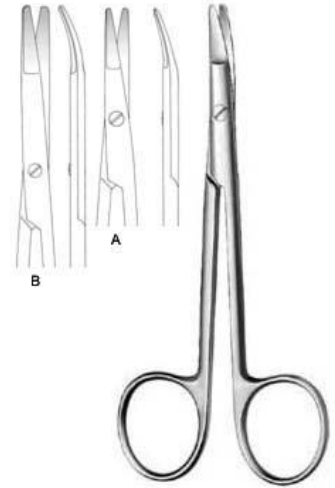

Kilner
JU-5-256-12
Dissecting Scissors
12 cm, 15 cm,

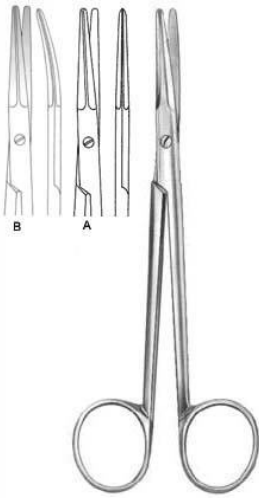
Scissors

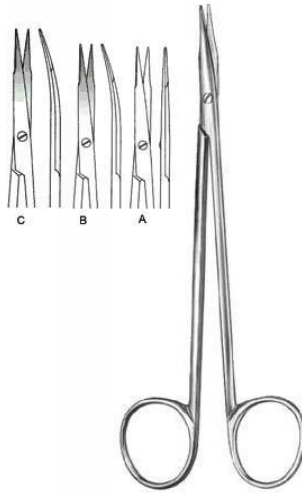
JU-5-257-14

 Dissecting Scissors
 14.5 cm,

Reynolds
JU-5-258-15

 Dissecting Scissors
 15.5 cm, 18 cm,

Jameson
JU-5-259-14

 Dissecting Scissors
 15.5 cm,

Jameson
JU-5-260-14

 Dissecting Scissors
 15.5 cm,

JU-5-261-19

 Vascular Scissors
 19 cm,

JU-5-262-24

 Vascular Scissors fine, short blades
 19 cm, 25.5 cm,

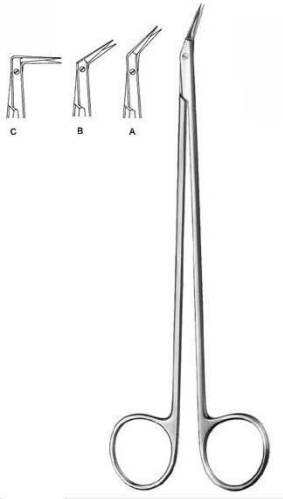
Scissors

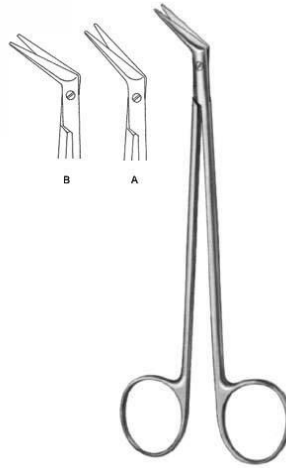
Diethrich
JU-5-263-25

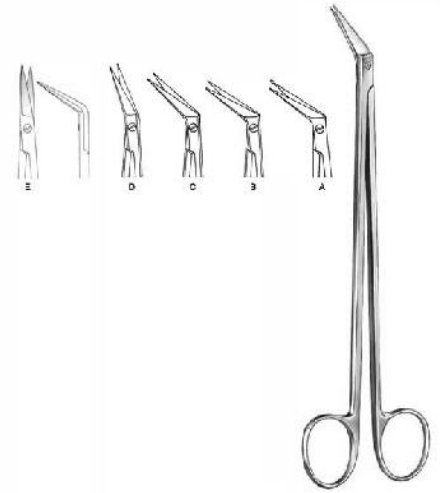
 Vascular Scissors
 19 cm, 18.5 cm, 17.5 cm,

DeBaKey
JU-5-264-45

 Vascular Scissors
 16.5 cm, 16 cm,

Potts-Smith
JU-5-265-19

 Vascular Scissors
 18 cm, 18.5 cm, 19 cm,

Coronary Scissors
JU-5-266-25

 Cardiovascular Surgery Scissor
 18 cm,

Coronary Scissors
JU-5-267-45

 Cardiovascular Surgery Scissors
 18 cm,

Coronary Scissors
JU-5-268-60

 Cardiovascular Surgery Scissor
 18 cm,

Scissors

Coronary Scissors
JU-5-269-90

Cardiovascular Surgery Scissor
18 cm,



Coronary Scissors
JU-5-270-00

Cardiovascular Surgery Scissor
18 cm,



Coronary Scissors
JU-5-271-00

Cardiovascular Surgery Scissor
18 cm,



Coronary Scissors
JU-5-272-25

Cardiovascular Surgery Scissor
18 cm,



Coronary Scissors
JU-5-273-45

Cardiovascular Surgery Scissor
18 cm,



Coronary Scissors
JU-5-274-90

Cardiovascular Surgery Scissor
18 cm,

Scissors



Schmieden-Taylor
JU-5-275-17
Dura Scissors
15 cm,



Strully
JU-5-276-22
Neurosurgical Scissors
22.5 cm,



Toennis-Adson
JU-5-277-17
Dissecting Scissors
17.5 cm,



Good
JU-5-279-19
Tonsil Scissors
19.5 cm,



Fomon
JU-5-282-15
Nasal Scissors
15 cm,



Cottle
JU-5-283-16
Nasal Scissors
16 cm,

Scissors



Heymann
JU-5-284-18
Nasal Scissors
18.5 cm,



Heymann
JU-5-285-18
Nasal Scissors
18.5 cm,



Converse
JU-5-286-11
Nasal Scissors blunt & sharp
10.5 cm,



Waldmann
JU-5-287-18
Episiotomy Scissors
18 cm,



Braun-Stadler
JU-5-288-14
Episiotomy Scissors
14.5 cm,



Braun-Stadler
JU-5-289-22
Episiotomy Scissors
22 cm,

Scissors

Modell USA
JU-5-290-10
 Umbilical Scissors
 10.5 cm,



Busch
JU-5-292-16
 Umbilical Scissors
 16 cm,



Goldmann-Fox
JU-5-293-13
 Gum Scissors
 13 cm,



Wagner
JU-5-294-12
 Operating Scissors
 12 cm,

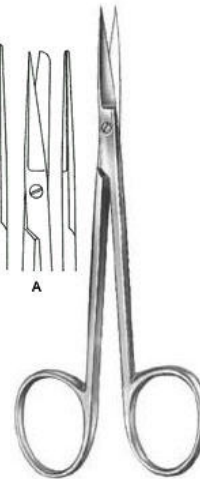
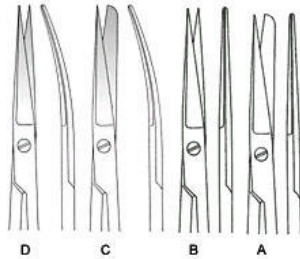

JU-5-295-12
 Operating Scissors small model
 12 cm,



La Grange
JU-5-296-11
 Gum Scissors S-shaped
 11.5 cm,

Scissors

JU-5-297-11
Dissecting Scissors delicate
11.5 cm,



Locklin
JU-5-298-16
Gum Scissors
16 cm,



Locklin
JU-5-299-16
Gum Scissors
16 cm,



JU-5-300-08
Operating Scissors very delicate
9 cm,

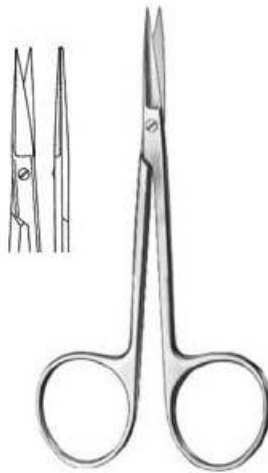

JU-5-301-10
Iris Scissors
9 cm, 10 cm,

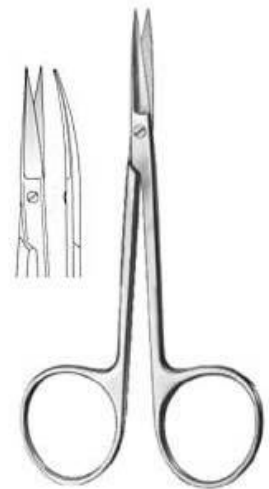

JU-5-302-10
Iris Scissors extra flat blades
10 cm,

Scissors



JU-5-303-10

Iris Scissors extra flat blades
10 cm,



Bonn

JU-5-304-09

Iris Scissors



Dean

JU-5-278-17

Tonsil Scissors
17.5 cm,



Spencer Scissor

JU-0-

Dressing & Tissue Forceps



Standard

JU-5-401-10

Dressing Forceps

10.5 cm, 11.5 cm, 13 cm, 14.5 cm, 16 cm, 18 cm, 20 cm, 23 cm, 25 cm, 30.5 cm,



Standard

JU-5-402-11

Dressing Forceps

12 cm, 13 cm, 14.5 cm, 16 cm, 18 cm, 20 cm, 25 cm, 30 cm,



JU-5-403-13

Dressing Forceps

13 cm, 14.5 cm,



Stille

JU-5-404-15

Dressing Forceps

15 cm,



Mini-Adson

JU-5-405-12

Dressing Forceps

12 cm,



Adson

JU-5-406-12

Dressing Forceps

12 cm, 15 cm,

Dressing & Tissue Forceps



McIndoe
JU-5-407-15
 Dressing Forceps
 15 cm,



Waugh
JU-5-408-20
 Dressing Forceps
 20 cm,



Semken
JU-5-409-12
 Dressing Forceps
 12.5 cm, 15 cm,



Taylor
JU-5-410-17
 Dressing Forceps
 12.5 cm, 15 cm,



Taylor
JU-5-411-17
 Dressing Forceps
 17 cm,



Taylor
JU-5-412-17
 Dressing Forceps
 18.5 cm,

Dressing & Tissue Forceps



JU-5-413-06
Micro Dressing Forceps
15.5 cm,



Gerald
JU-5-414-18
Dressing Forceps
15.5 cm,



Cushing
JU-5-415-17
Dressing Forceps
17.5 cm,



Potts-Smith
JU-5-416-18
Dressing Forceps
18 cm, 21 cm, 24.5 cm,



Bonney
JU-5-417-17
Dissecting Forceps
17.5 cm,



Gerald
JU-5-418-17
Dissecting Forceps
17.5 cm,

Dressing & Tissue Forceps



Gillies
JU-5-419-15
 Dissecting Forceps
 15.5 cm,



McIndoe
JU-5-420-15
 Dressing Forceps
 15 cm,



Semken
JU-5-421-16
 Dissecting Forceps
 15.5 cm, 17.5 cm,



Adson-Brown
JU-5-422-12
 Dissecting Forceps
 12 cm,



Adson
JU-5-423-12
 Dissecting Forceps
 12 cm, 15 cm,



Adson
JU-5-424-12
 Dressing Forceps
 12 cm, 15 cm,

Dressing & Tissue Forceps

Cushing
JU-5-425-17
 Dressing Forceps
 17.5 cm,



Cushing
JU-5-426-18
 Dressing Forceps
 17 cm,



Cushing-Taylor
JU-5-427-18
 Dressing Forceps
 18.5 cm,



Potts-Smith
JU-5-428-15
 Dressing Forceps
 16 cm, 18.5 cm, 20 cm, 23 cm, 25 cm,



Oehler
JU-5-429-14
 Dissecting Forceps
 14.5 cm, 16 cm, 18 cm, 20 cm, 25 cm,



Wangensteen
JU-5-430-15
 Dressing Forceps
 15 cm, 23 cm,

Dressing & Tissue Forceps



DeBakey

JU-5-431-15

Atraumatic Dressing Forceps

16 cm, 20 cm, 24.5 cm, 16 cm, 20 cm, 24.5 cm,



DeBakey

JU-5-432-16

Atraumatic Dressing Forceps

16 cm, 20 cm, 24 cm,

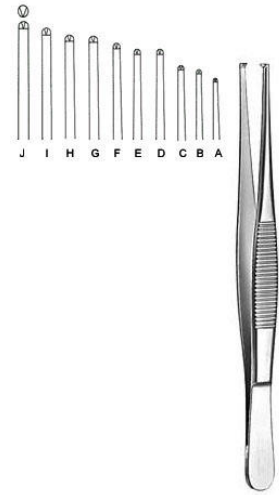

JU-5-433-10

Dissecting Forceps

10.5 cm, 11.5 cm, 13 cm, 14.5 cm, 16 cm, 18 cm, 20 cm, 23 cm, 25 cm, 30.5 cm,

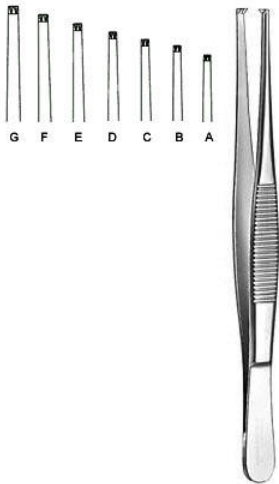

JU-5-434-11

Dissecting Forceps

12 cm, 13 cm, 14.5 cm, 15.5 cm, 18 cm, 20 cm, 24.5 cm,



JU-5-435-14

Dissecting Forceps

14.5 cm, 16 cm,



JU-5-436-14

Dissecting Forceps

14.5 cm, 16 cm,

Dressing & Tissue Forceps

JU-5-437-13
Dissecting Forceps
13 cm, 14.5 cm, 16 cm, 20 cm,



JU-5-438-13
Dissecting Forceps
13 cm, 14.5 cm,



Stille
JU-5-439-15
Dissecting Forceps
15 cm,



Stille
JU-5-440-15
Dissecting Forceps
15 cm,



Stone
JU-5-441-15
Dissecting Forceps
15 cm,



Lerche
JU-5-442-15
Dissecting Forceps
15 cm,

Dressing & Tissue Forceps

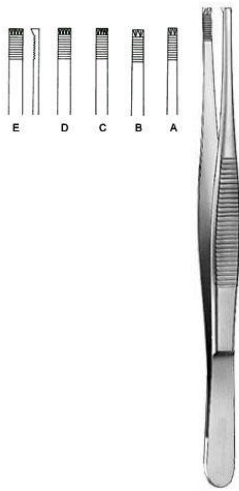

Adlerkreutz

JU-5-443-15

Dissecting Forceps
15.5 cm, 20.5 cm, 16 cm, 20 cm, 25 cm,

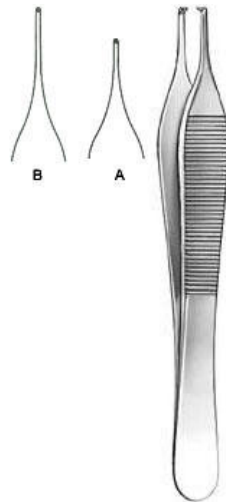

Adson

JU-5-444-12

Dissecting Forceps
12 cm, 15 cm,



Gillies

JU-5-445-15

Dissecting Forceps
15.5 cm,



Waugh

JU-5-446-20

Dissecting Forceps
20.5 cm,



Semken

JU-5-447-12

Dissecting Forceps
12.5 cm, 15 cm,



Taylor

JU-5-448-17

Dissecting Forceps
17.5 cm,

Dressing & Tissue Forceps



Taylor
JU-5-449-17
Dissecting Forceps
17 cm,



Taylor
JU-5-450-17
Dissecting Forceps
18.5 cm,



JU-5-451-06
Micro Dissecting Forceps
15.5 cm,



Gerald
JU-5-452-17
Dissecting Forceps
17.5 cm,



Cushing
JU-5-453-17
Dissecting Forceps
18 cm,

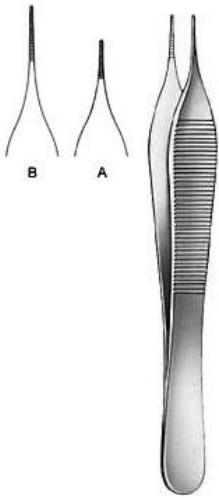

Potts-Smith
JU-5-454-18
Dissecting Forceps
18 cm, 21 cm, 24 cm,

Dressing & Tissue Forceps

Mikro-Adson
JU-5-455-12
 Dressing Forceps
 12 cm, 15 cm,

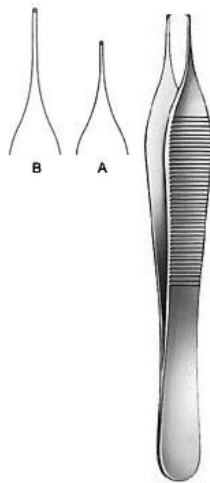

Mikro-Adson
JU-5-456-12
 Dissecting Forceps
 12 cm, 15 cm,



JU-5-457-11
 Dissecting Forceps
 10.5 cm,



Micro Jewelers
JU-5-458-12
 Jeweler Type Forceps
 12 cm Fig. 7,



Jewelers
JU-5-459-12
 Jeweler Type Forceps
 12 cm Fig. 3,



Jewelers
JU-5-460-11
 Jeweler Type Forceps
 11 cm Fig. 3c,

Dressing & Tissue Forceps

Jewelers
JU-5-461-11
 Jeweler Type Forceps
 11 cm Fig. 5,



Jewelers
JU-5-462-11
 Jeweler Type Forceps
 11 cm Fig. 4,



Stille-Barraya
JU-5-463-18
 Dissecting Forceps
 18 cm,



Bonney
JU-5-464-18
 Dissecting Forceps
 17.5 cm,



Nelson
JU-5-465-23
 Dissecting Forceps
 23 cm,



JU-5-466-10
 Dressing Forceps
 10 cm, 9.5 cm,

Dressing & Tissue Forceps

JU-5-467-12
Splinter Forceps smooth jaw
12.5 cm,



JU-5-468-12
Splinter Forceps smooth jaw
12.5 cm,



JU-5-469-12
Splinter Forceps
12.5 cm,



JU-5-470-12
Splinter Forceps
12.5 cm,



JU-5-471-16
Micro Tying Forceps
15.5 cm,



JU-5-472-10
Microscopic Forceps super light, blunt
10 cm,

Dressing & Tissue Forceps



JU-5-473-10
Microscopic Forceps
10 cm,



Shaaf
JU-5-474-09
Splinter Forceps
9.5 cm,



Littauer
JU-5-475-08
Cilia Forceps
8.5 cm,



JU-5-476-09
Cilia Forceps
8.5 cm,



Douglas
JU-5-477-09
Cilia Forceps
9 cm,



Douglas
JU-5-478-09
Cilia Forceps
9 cm,

Dressing & Tissue Forceps



Beer
JU-5-479-09
Cilia Forceps
9 cm,

Splinter Forceps

Phaneuf
JU-5-501-21
 Hysterectomy Forceps
 20.5 cm,



Wertheim-Cullen
JU-5-502-21
 Vaginal Clamp
 21 cm,

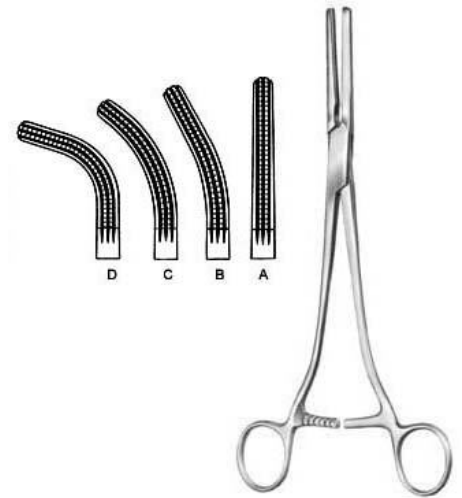

Rogers
JU-5-503-10
 Hysterectomy Forceps
 21.5 cm Fig. 1, 21 cm Fig. 2, 20.5 cm Fig. 3, 20 cm Fig. 4,



Moynihan
JU-5-504-23
 Hysterectomy Forceps
 23 cm,



Moynihan
JU-5-505-24
 Hysterectomy Forceps
 23.5 cm,

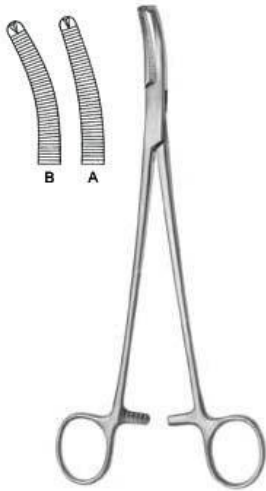

Wertheim
JU-5-506-25
 Hysterectomy Forceps
 26 cm,

Splinter Forceps

Wertheim
JU-5-507-22
 Hysterectomy Forceps
 22.5 cm,



Mikulicz, Baby
JU-5-508-14
 Peritoneum Forceps
 14.5 cm,



Mikulicz
JU-5-509-18
 Peritoneum Forceps
 20.5 cm,



Mikulicz
JU-5-510-20
 Peritoneum Forceps
 18.5 cm,



Mikulicz
JU-5-511-20
 Peritoneum Forceps
 20 cm,



Mikulicz
JU-5-512-21
 Peritoneum Forceps
 20.5 cm,

Splinter Forceps



Faure
JU-5-513-20
Peritoneum Forceps
21 cm,

Haemostatic Forceps

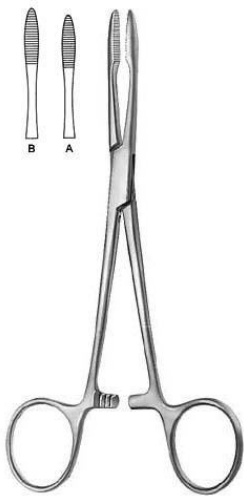

Pean

JU-5-601-14

Haemostatic Forceps
14.5 cm, 16 cm,

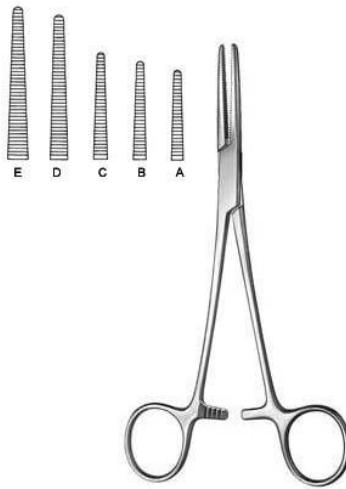

Spencer-Wells

JU-5-602-13

Haemostatic Forceps
13 cm, 14 cm, 15.5 cm, 18.5 cm, 20 cm,

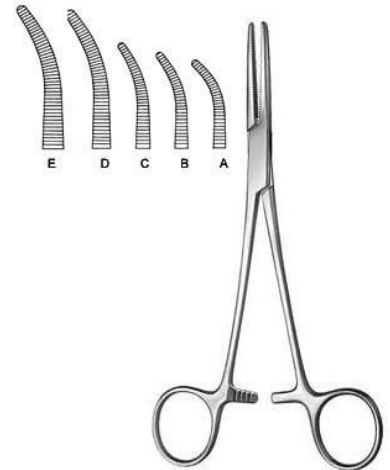

Spencer-Wells

JU-5-603-13

Haemostatic Forceps
13 cm, 14 cm, 15 cm, 18 cm, 20 cm,



Chaput

JU-5-604-13

Haemostatic Forceps
12.5 cm,



Tuffier

JU-5-605-13

Haemostatic Forceps
12.5 cm,

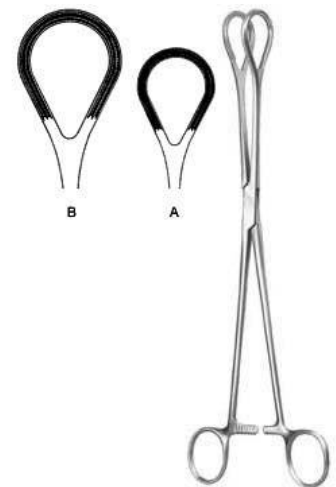

JU-5-606-25

Organ Grasping Forceps

Haemostatic Forceps



Collin
JU-5-607-14
Organ Grasping Forceps
15.5 cm, 21 cm,



Collin
JU-5-608-17
Tumor Grasping Forceps
17 cm,



Pennington
JU-5-609-15
Haemostatic Forceps
15.5 cm,



Pratt
JU-5-610-15
Haemostatic Forceps
15 cm,



Martel-Rees
JU-5-611-14
Face-lift Forceps
13.5 cm,

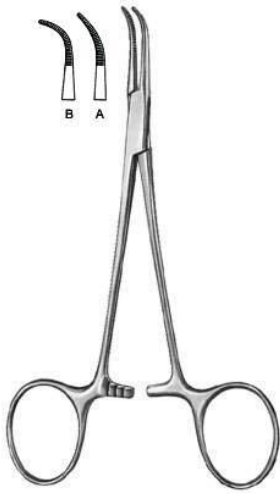

JU-5-612-12
Ligature Forceps

Haemostatic Forceps

Mixer-Baby
JU-5-613-01

Dissecting and Ligature Forceps
13.5 cm, 13 cm,

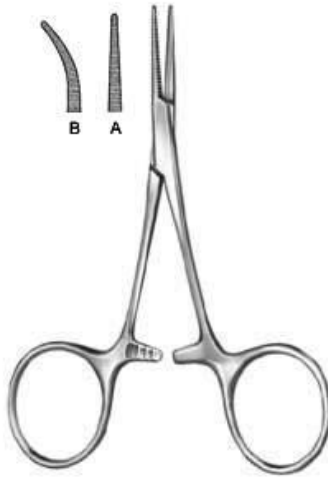

Hartmann
JU-5-614-10
Haemostatic Forceps
10 cm, 9.5 cm,



JU-5-615-12
Ligature Forceps

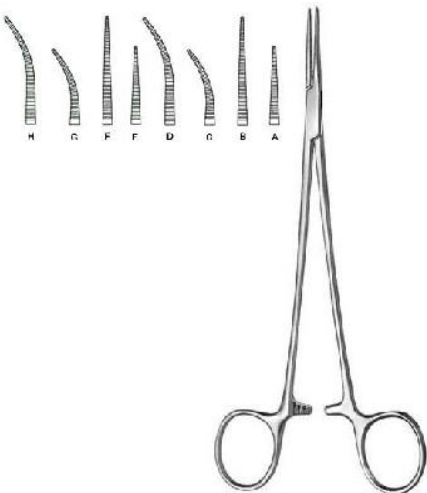

Halsted-Mosquito
JU-5-616-18
Haemostatic Forceps
12.5 cm, 14.5 cm, 14 cm,

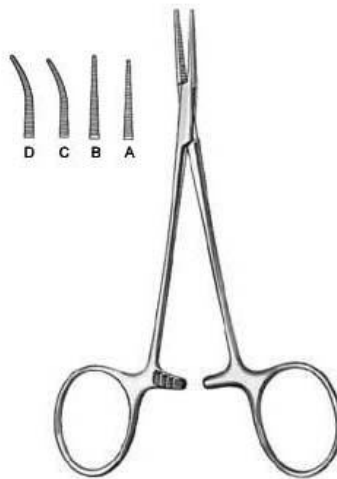

Mikro-Mosquito
JU-5-617-10
Haemostatic Forceps
10 cm, 12 cm, 9.5 cm, 11.5 cm,



Providence-Hospital
JU-5-618-14
Haemostatic Forceps
14 cm,

Haemostatic Forceps

Leriche
JU-5-619-15

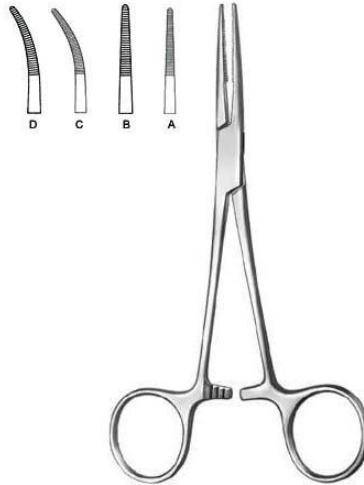
 Haemostatic Forceps
 15.5 cm, 15 cm,

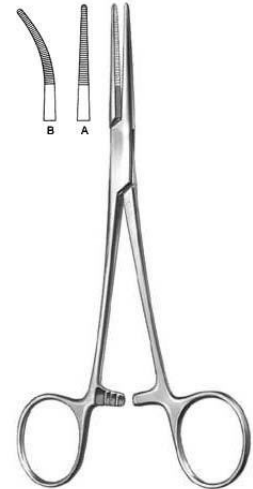
Kelly
JU-5-620-14

 Haemostatic Forceps
 14.5 cm, 14 cm,

Kelly-Rankin
JU-5-621-16

 Haemostatic Forceps
 16 cm, 15.5 cm,

Overholt-Baby
JU-5-622-14

 Dissecting and Ligature Forceps
 14.5 cm, 14 cm,

Crile
JU-5-623-14

 Haemostatic Forceps
 14.5 cm, 14 cm,

Crile-Rankin
JU-5-624-16

 Haemostatic Forceps
 16.5 cm, 16 cm,

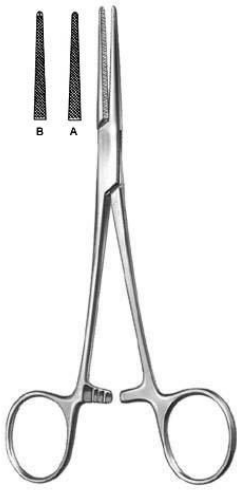
Haemostatic Forceps

Lovelace
JU-5-625-15
 Haemostatic Forceps
 16 cm,



Dandy-Mosquito
JU-5-626-12
 Haemostatic Forceps
 12 cm,

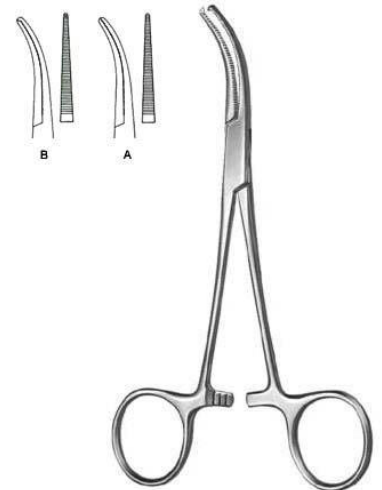

Dandy
JU-5-627-14
 Haemostatic Forceps
 14.5 cm, 14 cm,



Schnidt
JU-5-628-18
 Dissecting and Ligature Forceps
 18.5 cm, 19 cm,



Adson
JU-5-629-18
 Dissecting and Ligature Forceps
 19 cm, 18.5 cm,

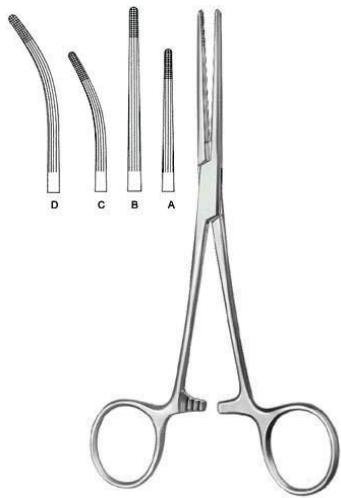

Martin-Fuchsig
JU-5-630-20
 Dissecting and Ligature Forceps
 20.5 cm,

Haemostatic Forceps

Rochester-Carmalt
JU-5-631-16

Haemostatic Forceps
17 cm, 20.5 cm, 16.5 cm, 20 cm,

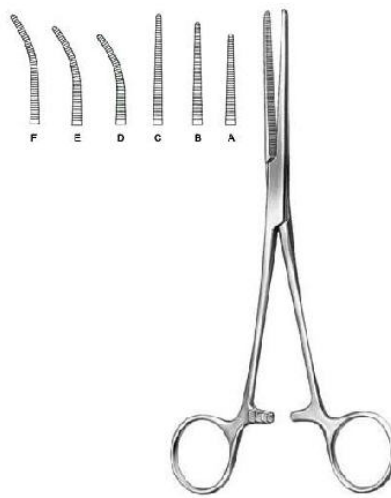

Pean
JU-5-632-13

Haemostatic Forceps
13.5 cm, 14.5 cm, 17 cm, 13 cm, 14 cm, 16.5 cm,

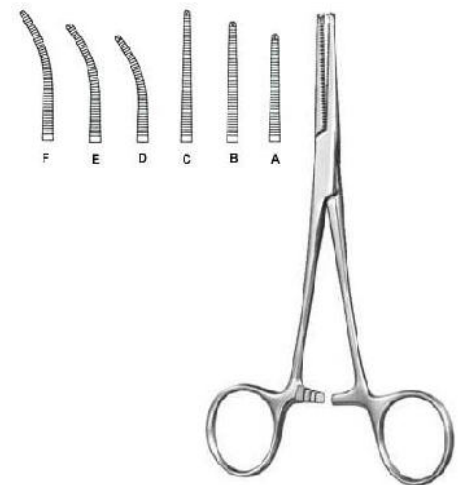

Kocher-Nippon
JU-5-633-14

Haemostatic Forceps
14.5 cm, 16.5 cm, 18.5 cm, 16 cm, 18 cm,

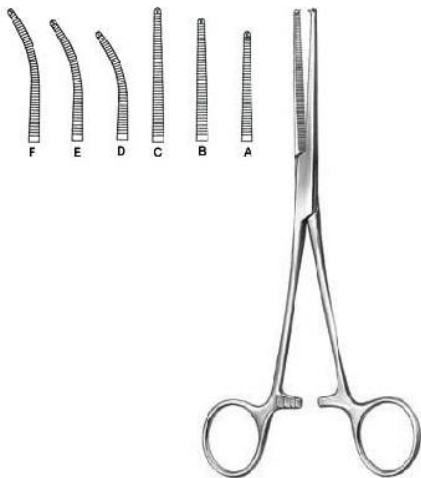

Kocher
JU-5-635-13

Haemostatic Forceps
13 cm, 14 cm, 16 cm,

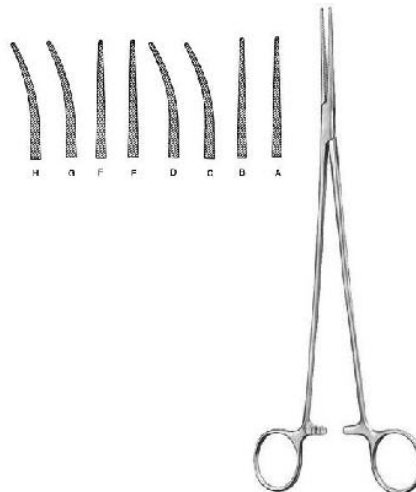

Bengolea
JU-5-636-20

Haemostatic Forceps
21.5 cm, 26 cm, 21 cm, 21.5 cm,

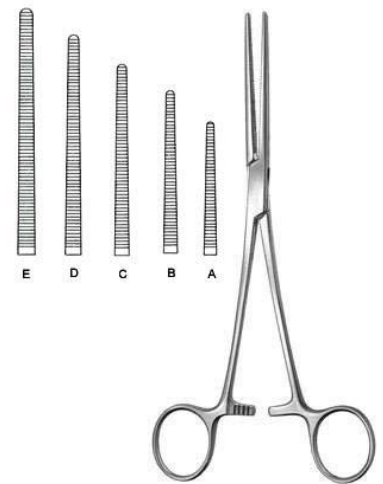

Pean (Rochester)
JU-5-637-14

Haemostatic Forceps
14.5 cm, 16.5 cm, 18.5 cm, 20.5 cm, 22.5 cm, 24.5 cm, 26 cm, 30.5 cm, 14 cm, 16 cm,

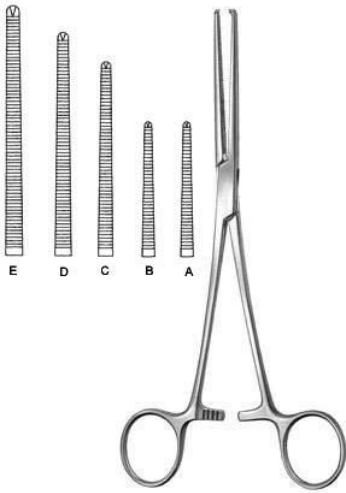
Haemostatic Forceps

Kocher (Ochsner)
JU-5-638-14

Haemostatic Forceps

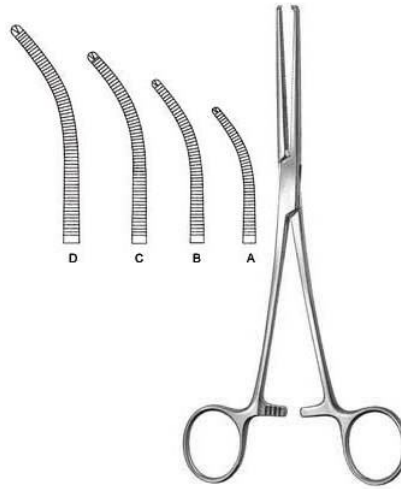
14.5 cm, 16.5 cm, 18.5 cm, 20.5 cm, 22.5 cm, 24.5 cm, 26 cm, 30.5 cm,

Kocher (Ochsner)
JU-5-639-14

Haemostatic Forceps

14 cm, 16 cm, 18 cm, 20 cm, 22 cm, 24 cm, 25.5 cm, 30 cm,

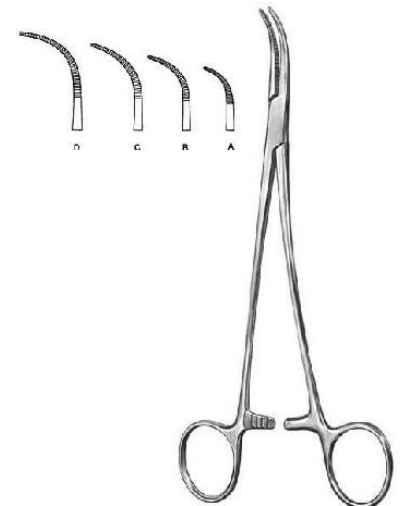
Overholt-Martin
JU-5-640-01

Dissecting and Ligature Forceps

18.5 cm Fig. 1, 20.5 cm Fig. 2, 21 cm Fig. 3, 21.5 cm Fig. 4, 24.5 cm Fig. 5,

Mixer-Baby
JU-5-641-18

Dissecting and Ligature Forceps

18.5 cm,

Adson-Baby
JU-5-642-14

Dissecting and Ligature Forceps

14.5 cm, 18 cm,

Heiss
JU-5-643-20

Dissecting and Ligature Forceps

21 cm, 20.5 cm, 20 cm,

Haemostatic Forceps

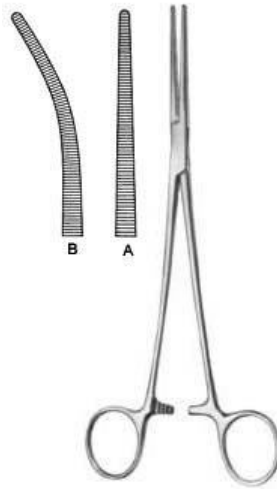

Overholt-Mixer
JU-5-644-21

Dissecting and Ligature Forceps
21.5 cm,

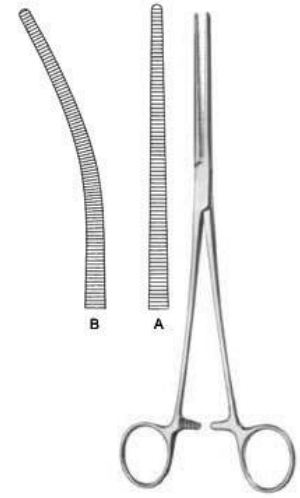

Roberts
JU-5-645-22

Dissecting and Ligature Forceps
22.5 cm, 21.5 cm,



Sarot
JU-5-646-24

Dissecting and Ligature Forceps
25 cm, 24.5 cm,

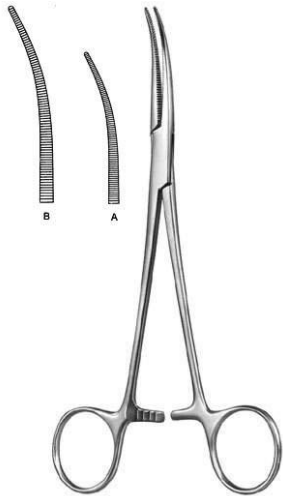

Craford
JU-5-647-18

Dissecting and Ligature Forceps
18 cm, 24.5 cm,

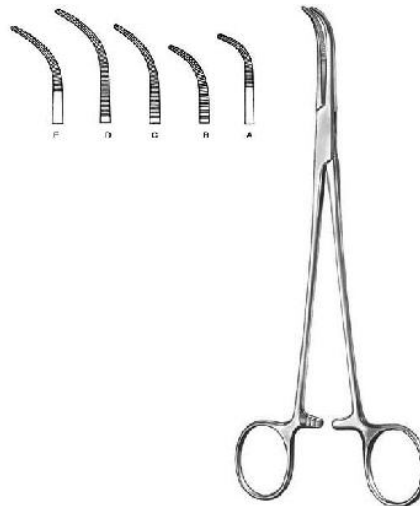

Overholt-Geissendorfer
JU-5-648-01

Dissecting and Ligature Forceps
20.5 cm Fig. 1, 20 cm Fig. 2, 21.5 cm Fig. 3, 22 cm Fig. 4, 21.5 cm Fig. 5, 22 cm Fig. 6, 27 cm Fig. 1, 26.5 cm Fig. 2, 27.5 cm Fig. 3, 28 cm Fig. 4,

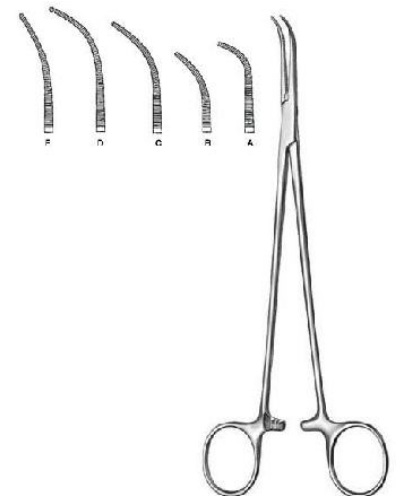

Overholt-Fino
JU-5-649-00

Dissecting and Ligature Forceps
21.5 cm, 21 cm, 22 cm, 23 cm, 22.5 cm,

Haemostatic Forceps

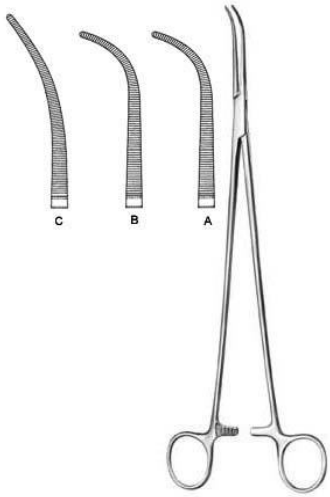

Overholt

JU-5-650-00

Dissecting and Ligature Forceps
29.5 cm, 30 cm,



Overholt-Mini

JU-5-651-01

Dissecting and Ligature Forceps
15 cm, 20 cm,

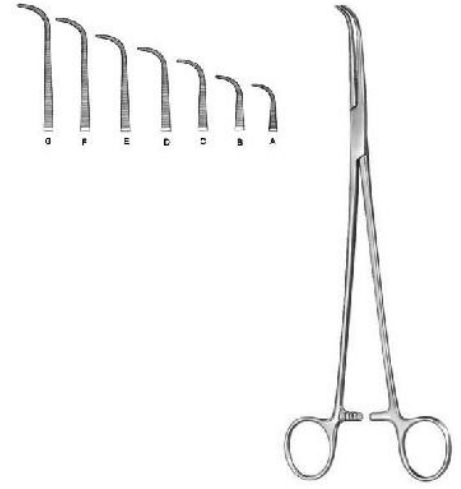

Gemini

JU-5-652-13

Dissecting and Ligature Forceps
13 cm, 16 cm, 18 cm, 21 cm, 23 cm, 25 cm, 28 cm,

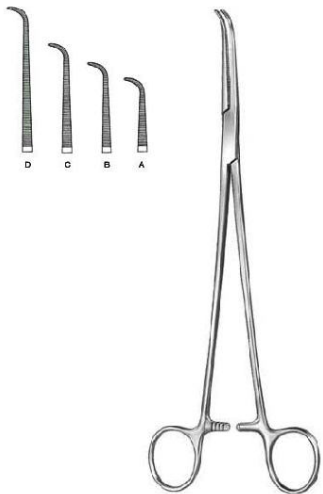

Mini-Gemini

JU-5-653-18

Dissecting and Ligature Forceps
18 cm, 22.5 cm, 25 cm, 28.5 cm,

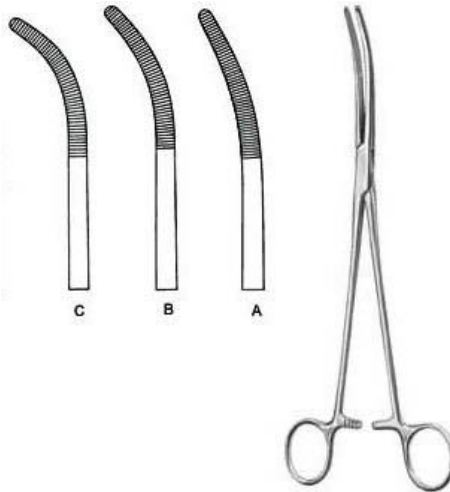

Rumel

JU-5-654-01

Dissecting and Ligature Forceps
24 cm Fig. 1, 23.5 cm Fig. 2, 23 cm Fig. 3, 24 cm Fig. 4, 23.5 cm Fig. 5,

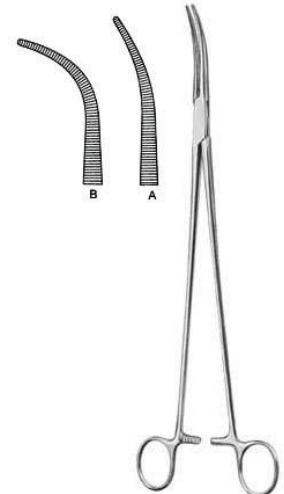

Zenker

JU-5-655-01

Dissecting and Ligature Forceps
29.5 cm, 28.5 cm,

Haemostatic Forceps

Mixer-Baby
JU-5-656-14

Dissecting and Ligature Forceps
13.5 cm,



Mixer

JU-5-657-15

Dissecting and Ligature Forceps
16 cm, 18 cm,



Mixer-O Shaughnessy

JU-5-658-19

Dissecting and Ligature Forceps
18 cm,



Mixer

JU-5-659-22

Dissecting and Ligature Forceps
22.5 cm,



Mixer

JU-5-660-23

Dissecting and Ligature Forceps
23 cm,



Wickstrom

JU-5-661-21

Dissecting and Ligature Forceps
21 cm, 24.5 cm,

Haemostatic Forceps

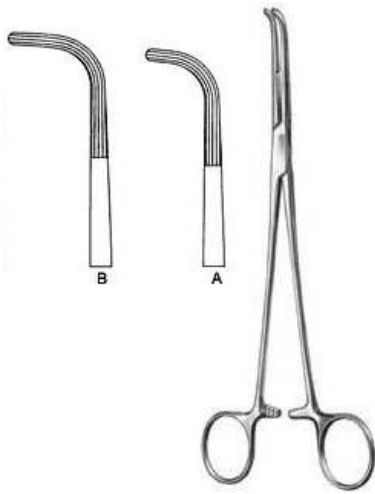

Mixer

JU-5-662-22

Dissecting and Ligature Forceps
22.5 cm, 26 cm, 28 cm,



Mc Quigg-Mixer

JU-5-663-22

Dissecting and Ligature Forceps
23.5 cm,



Lower

JU-5-664-18

Dissecting and Ligature Forceps
18.5 cm,

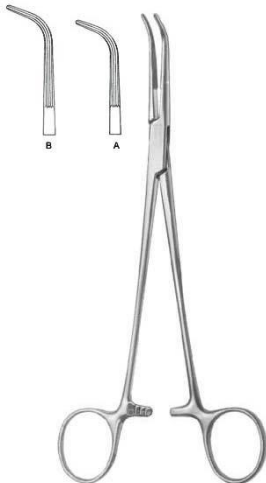

Lahey

JU-5-665-19

Bile Duct Clamp
19.5 cm, 22.5 cm,



Finochietto

JU-5-666-24

Dissecting and Ligature Forceps
24 cm,



Uro-Tangential

JU-5-667-01

Tangential Forceps
25 cm, 27 cm,

Haemostatic Forceps

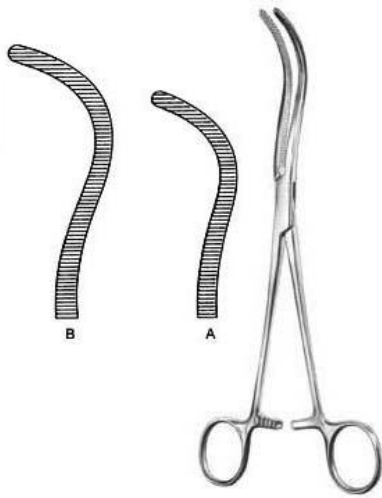

Guyon

JU-5-668-20

Kidney Pedicle Clamp
23 cm, 24 cm,



Guyon

JU-5-669-23

Kidney Pedicle Clamp
19.5 cm, 21.5 cm, 24 cm,



Desjardins

JU-5-670-21

Bile Duct Clamp
21 cm,

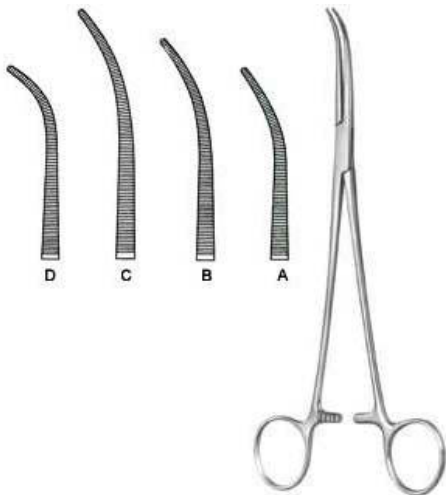

Kelly

JU-5-671-19

Dissecting and Ligature Forceps

19.5 cm Fig. 1, 22.5 cm Fig. 1, 24.5 cm Fig. 1,
19 cm Fig. 2, 22 cm Fig. 2, 24 cm Fig. 2,
18.5 cm Fig. 3, 21.5 cm Fig. 3, 23.5 cm Fig. 3,



Lawrence

JU-5-672-28

Dissecting and Ligature Forceps
28 cm,



Meeker

JU-5-673-28

Dissecting and Ligature Forceps
28 cm,

Haemostatic Forceps

Negus

JU-5-674-19

Haemostatic Forceps
19.5 cm Fig. 1, 20 cm Fig. 2,

Towel & Tubing Clamps

Schaedel
JU-5-701-09
 Towel Clamp sharp
 9 cm,



Jones
JU-5-702-05
 Towel Clamp sharp
 5.5 cm, 8.5 cm,



Jones-Martin
JU-5-703-09
 Towel Clamp sharp
 8.5 cm,



Backhaus
JU-5-704-11
 Towel Clamp
 11.5 cm, 13 cm,



Backhaus
JU-5-705-11
 Towel Clamp
 11.5 cm,



Backhaus
JU-5-706-08
 Towel Clamp
 9 cm, 11.5 cm, 13 cm, 16 cm,

Towel & Tubing Clamps

Peers-Bertram modif.
JU-5-707-15

 Towel Clamp wide jaw for tube fixation
15.5 cm,

Rieder
JU-5-708-13

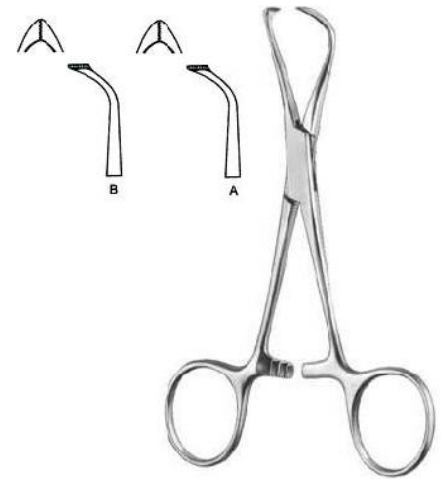
 Towel Clamp
13.5 cm,

Lorna
JU-5-709-10

 Towel Clamp fine serrated, wide jaw
9.5 cm, 13 cm,

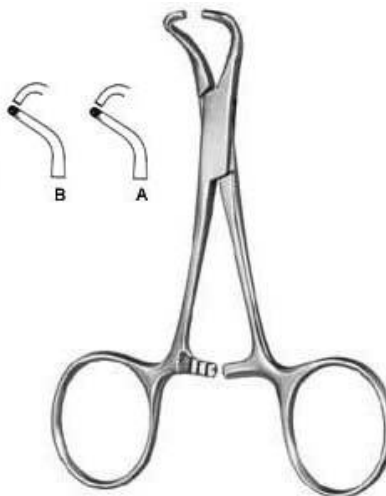
Bernhard
JU-5-710-16

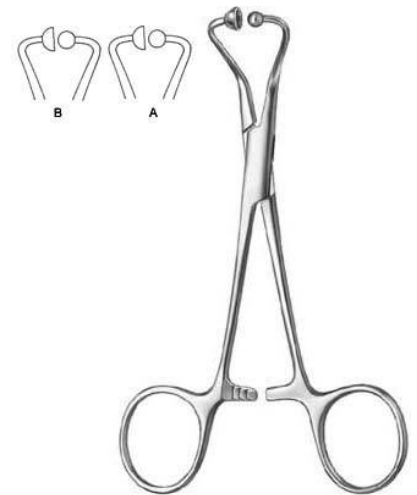
 Towel Clamp
16.5 cm,

Tohoku
JU-5-711-10

 Towel Clamp
10.5 cm blunt, 13.5 cm blunt, 14.5 cm,

JU-5-712-11

 Towel Clamp for paper clothes
11.5 cm, 14 cm,

Towel & Tubing Clamps

Lane
JU-5-713-20
 Towel Clamp
 19.5 cm,



JU-5-714-06
 Tube Holder for fixation of six tubes



JU-5-715-14
 Tubing Clamp extra long ratchet
 14 cm,



JU-5-716-16
 Tubing Clamp
 16.5 cm,

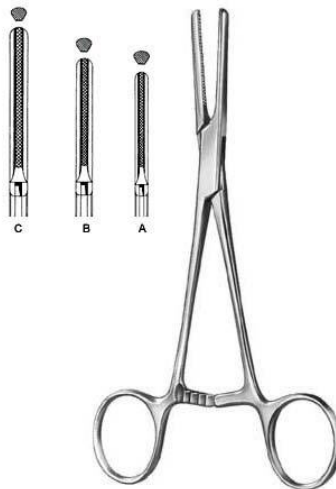

JU-5-717-15
 Tubing Clamp
 15.5 cm, 19 cm, 20.5 cm,

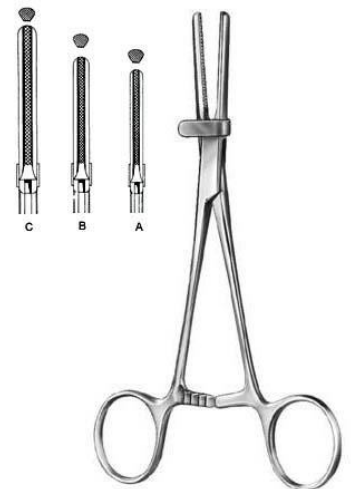

JU-5-718-15
 Tubing Clamp with safety guard
 15.5 cm, 19 cm, 20.5 cm,

Dressing & Sponge Forceps

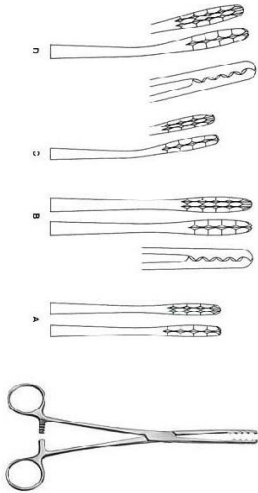

Ulrich

JU-5-801-22

Dressing Forceps
22.5 cm, 26.5 cm,



Lister

JU-5-802-13

Sinus Forceps
13 cm, 16 cm, 18 cm,



Martin

JU-5-803-17

Dressing Forceps
17.5 cm, 17 cm,

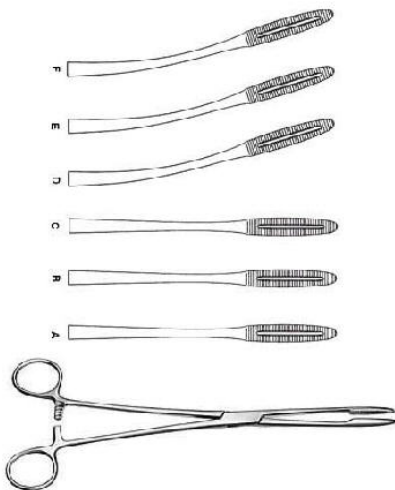

Gross-Maier

JU-5-804-20

Dressing Forceps
20.5 cm, 22 cm, 26.5 cm, 20 cm, 21.5 cm, 26 cm,



JU-5-805-40

Tunneling Forceps
39.5 cm,



Collin

JU-5-806-25

Dressing Forceps
25.5 cm,

Dressing & Sponge Forceps



Cheron
JU-5-807-25
 Dressing Forceps
 23.5 cm,



Bozemann
JU-5-808-26
 Sponge Forceps
 26 cm,

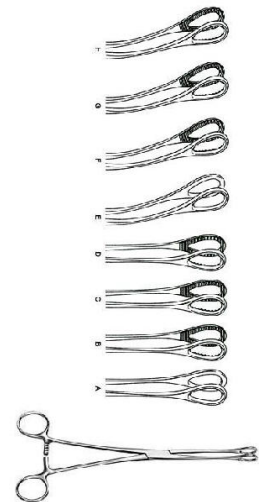

Foerster
JU-5-809-25
 Sponge Forceps
 25 cm, 18 cm, 20.5 cm, 24.5 cm, 17.5 cm, 20 cm, 24.5 cm,

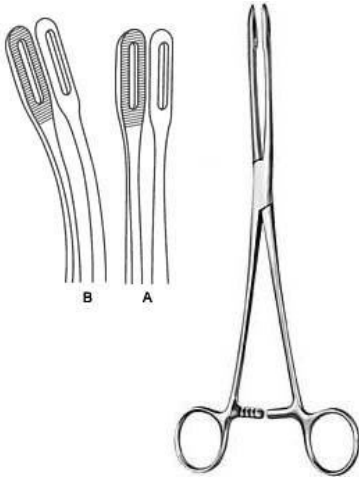

Foerster
JU-5-810-25
 Sponge Forceps
 25 cm, 24.5 cm,

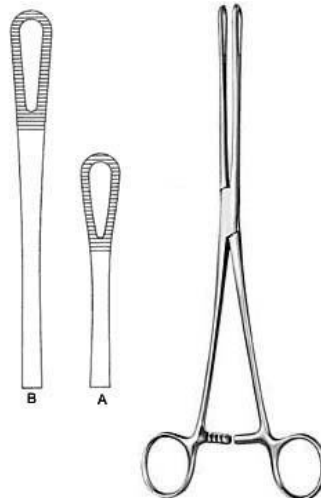

Rampley
JU-5-811-18
 Sponge Forceps
 18.5 cm, 24.5 cm,

Retractors

Vickers
JU-5-901-18
 Skin Hooklet
 18.5 cm,



Vickers
JU-5-902-01
 Bone Hooklet
 17 cm,



Vickers
JU-5-903-01
 Tendon Hooklet
 17 cm,



Vickers
JU-5-904-02
 Hooklet
 16 cm,

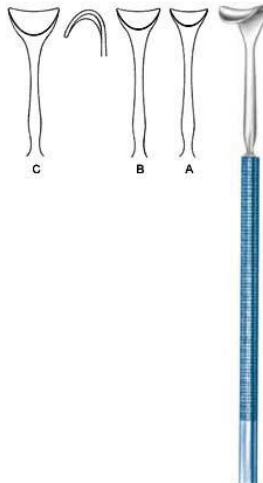

Vickers
JU-5-905-12
 Saddle Hook
 14 cm,

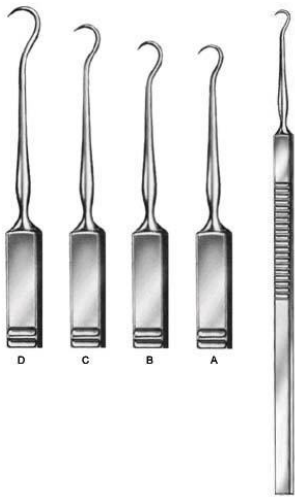

Graefe
JU-5-906-01
 Micro Hooklet
 15 cm,

Retractors

JU-5-907-01

Skin Hook

16 cm Fig. 1, 16 cm Fig. 2, 16 cm Fig. 3, 16 cm Fig. 4,

O Connor
JU-5-908-16

Skin Hook

16 cm,

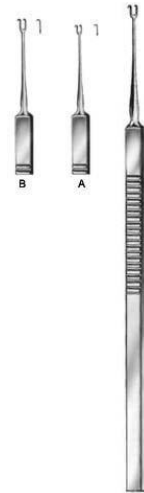
Guthrie
JU-5-909-01

Skin Hook

15.5 cm,

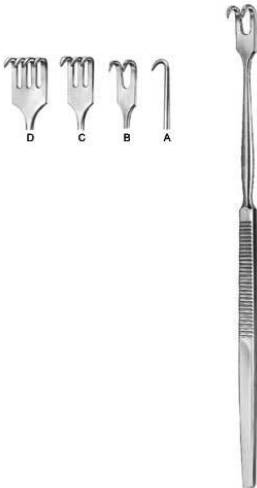
JU-5-910-01

Hooklet

16.5 cm,

JU-5-911-01

Hooklet

16.5 cm,

JU-5-912-02

Hooklet

16 cm,

Retractors



JU-5-913-04
Hooklet
16.5 cm,

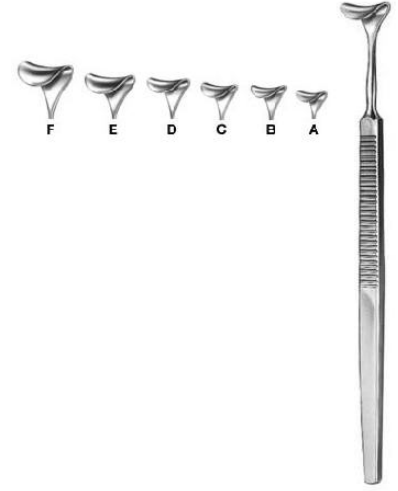

JU-5-914-12
Vessel Hook
12 cm,

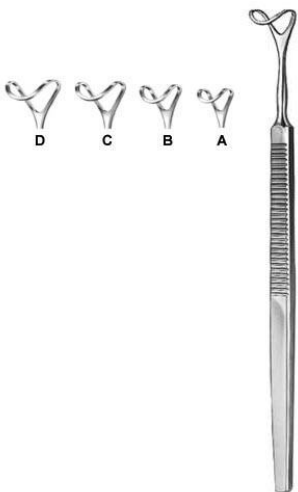

Desmarres
JU-5-915-08
Saddle Hook
16 cm 8 mm, 16 cm 10 mm, 16 cm 12 mm, 16 cm 14 mm, 16 cm 16 mm, 16 cm 18 mm,



JU-5-916-12
Saddle Hook
16 cm 12 mm, 16 cm 14 mm, 16 cm 16 mm, 16 cm 18 mm,

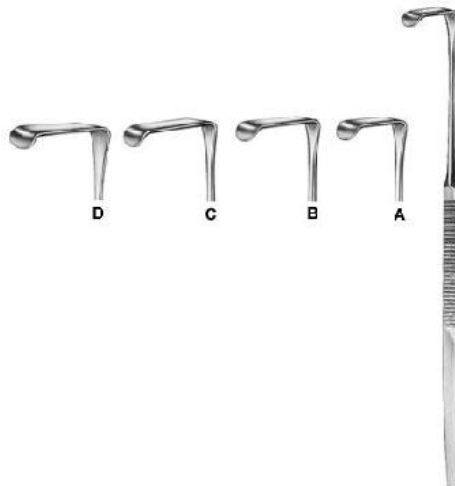

Langenbeck-Mini
JU-5-917-10
Hooklet
16 cm,



JU-5-918-16
Hooklet
16 cm 14 x 8,

Retractors

JU-5-919-01
Hooklet
16.5 cm,



JU-5-920-01
Hooklet
16.5 cm,



Meyerding
JU-5-921-01
Hooklet
17.5 cm Fig. 1, 17.5 cm Fig. 2, 17.5 cm Fig. 3, 17.5 cm Fig. 4, 17.5 cm Fig. 5, 17.5 cm Fig. 6,



Senn-Green
JU-5-922-01
Hooklet
15 cm Fig. 1, 15 cm Fig. 2,



Ragnell-Davis
JU-5-923-14
Hooklet
14 cm,

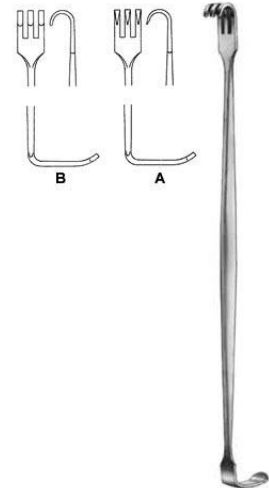

Senn-Miller
JU-5-924-16
Hooklet
16 cm,

Retractors

Cushing
JU-5-925-20
 Retractor
 20.5 cm,



Cushing
JU-5-926-08
 Saddle Hook
 20.5 cm 8 mm wide, 20.5 cm 10 mm wide, 20.5 cm 12 mm wide, 20.5 cm 14 mm wide, 20.5 cm 16 mm wide, 20.5 cm 18 mm wide,

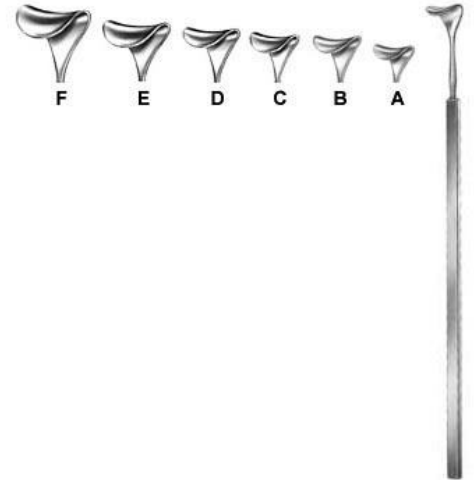

Cushing
JU-5-927-08
 Saddle Hook 8 mm to 18 mm wide
 24 cm,



Brom
JU-5-928-01
 Vein Hook
 19.5 cm,



Strandell-Stille
JU-5-929-01
 Hooklet
 19 cm Fig. 1, 19 cm Fig. 2,

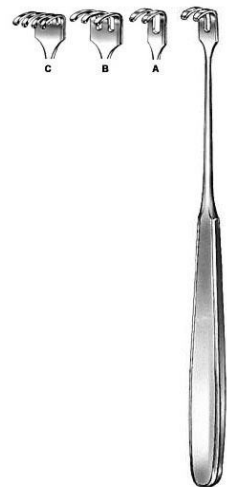

Klapp
JU-5-930-01
 Retractor 12 x 6, 12 x 11, 15 x 11
 17.5 cm,

Retractors

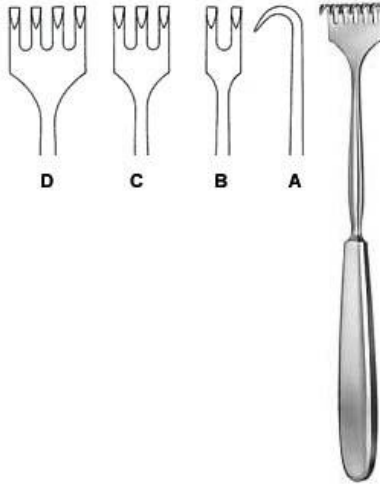

JU-5-931-04
Hooklet
16.5 cm,

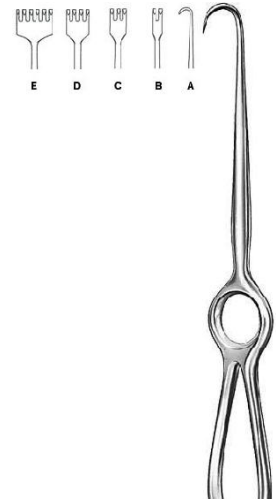

Volkmann
JU-5-932-01
Retractor
21.5 cm,

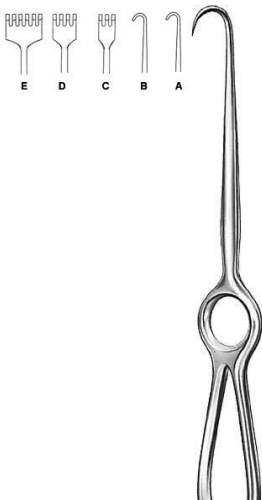

Volkmann
JU-5-933-01
Retractor
22 cm, 21.5 cm,



Kocher
JU-5-934-01
Retractor
22 cm,

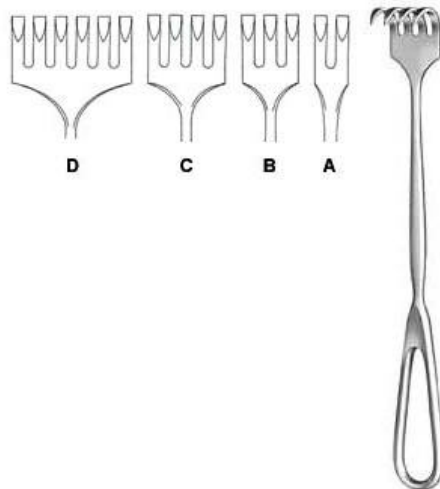

Martin
JU-5-935-02
Retractor
22.5 cm,

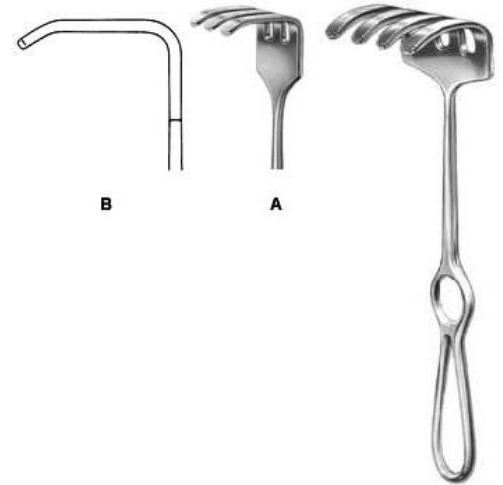

Ollier
JU-5-936-03
Retractor
23 cm 36 x 30, 23 cm 36 x 60,

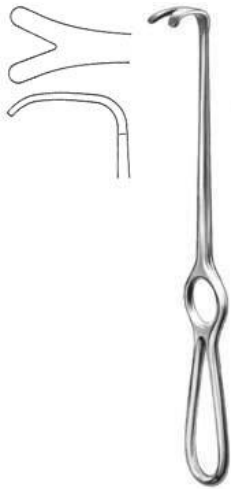
Retractors

Wassmund
JU-5-937-02
 Retractor
 20.5 cm 33 x 21,

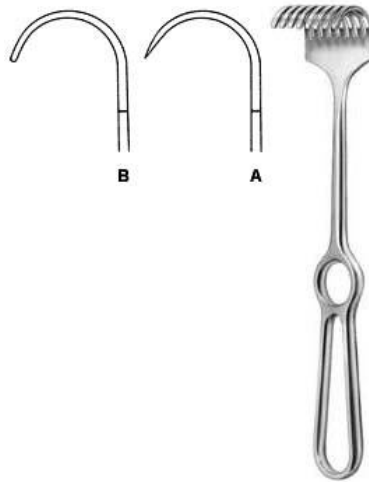

Korte
JU-5-938-08
 Retractor
 24.5 cm 40 x 30,

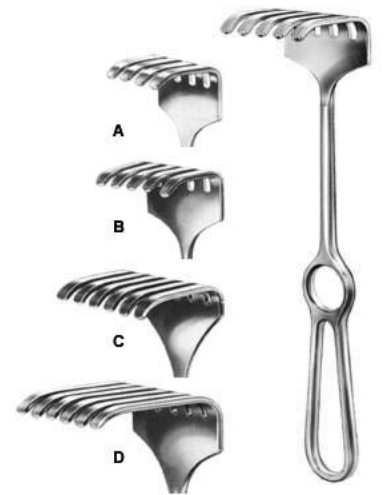

Israel
JU-5-939-04
 Retractor
 25.5 cm,

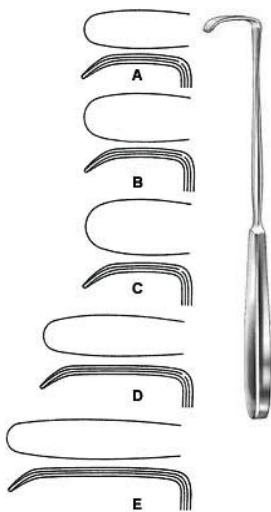

Langenbeck
JU-5-940-01
 Retractor
 22.5 cm 30 x 11 mm, 22.5 cm 30 x 14 mm, 22.5 cm 30 x 16 mm, 22.5 cm 40 x 11 mm, 22.5 cm 50 x 11 mm,

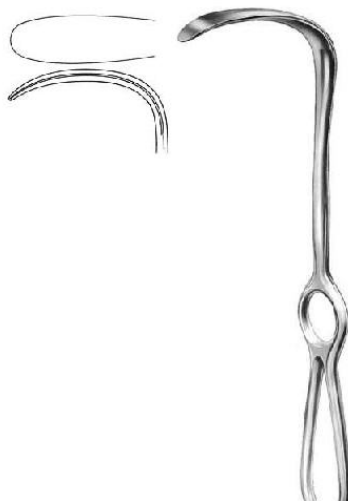

Langenbeck
JU-5-942-21
 Retractor
 21 cm 65 x 20 mm,



Langenbeck
JU-5-943-21
 Retractor
 22.5 cm 85 x 15 mm,

Retractors



Lahey
JU-5-944-19
 Retractor
 19.5 cm 36 x 19 mm,

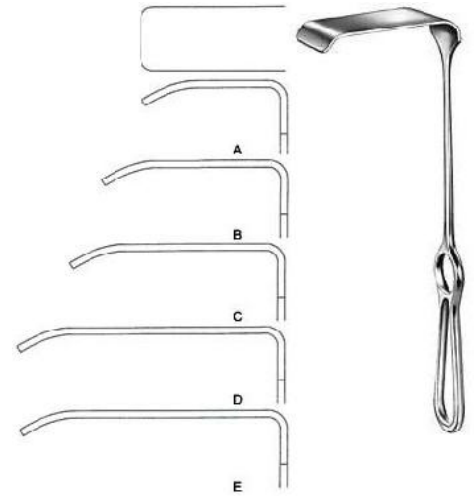

Little
JU-5-945-20
 Retractor
 20 cm 13 x 15 mm,

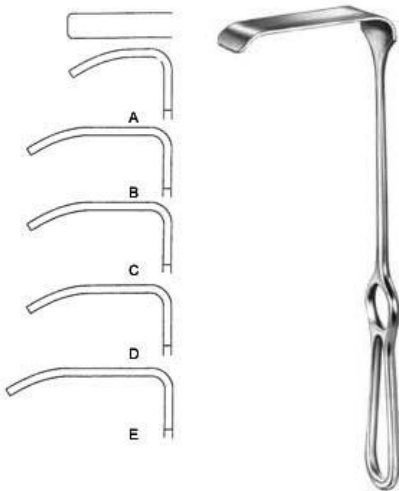

Kocher
JU-5-946-18
 Retractor
 23 cm 43 x 18 mm, 23 cm 53 x 20 mm, 23 cm
 63 x 25 mm, 23 cm 77 x 30 mm, 23 cm 78 x
 40 mm,



Kocher-Langenbeck
JU-5-947-01
 Retractor
 21.5 cm 25 x 6 mm, 21.5 cm 35 x 8 mm, 21.5
 cm 35 x 11 mm, 21.5 cm 35 x 15 mm, 21.5
 cm 40 x 11 mm, 21.5 cm 55 x 11 mm, 21.5
 cm 70 x 14 mm, 21.5 cm 80 x 12 mm,

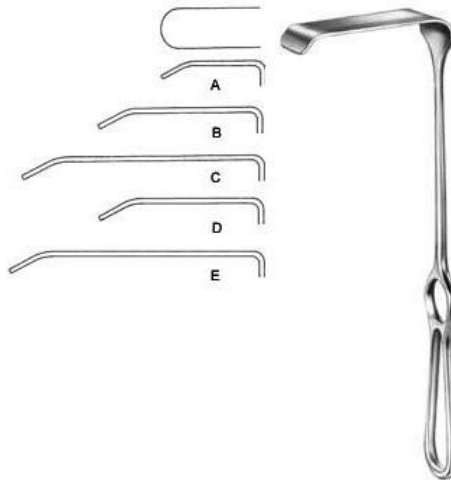

Kocher-Langenbeck
JU-5-948-01
 Retractor
 21.5 cm 25 x 10 mm, 21.5 cm 40 x 13
 mm, 21.5 cm 60 x 13 mm, 21.5 cm 40 x 18
 mm, 21.5 cm 60 x 18 mm, 21.5 cm 85 x 18
 mm, 21.5 cm 60 x 25 mm, 21.5 cm 85 x 25
 mm,

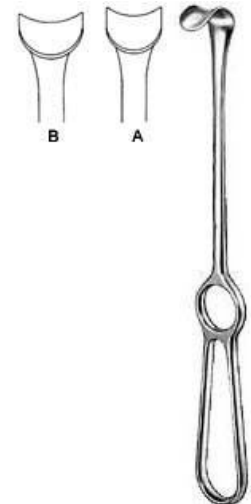

Kocher
JU-5-949-01
 Retractor
 21.5 cm 22 x 12 mm, 21.5 cm 24 x 14 mm,

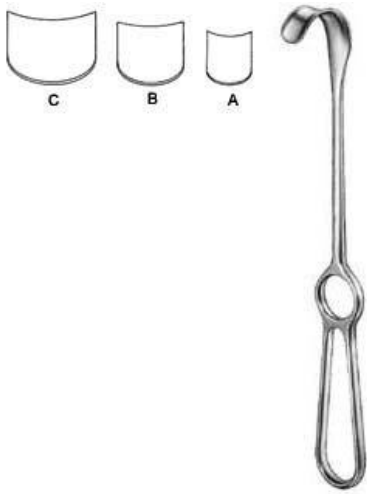
Retractors

Kocher
JU-5-950-01

Retractor

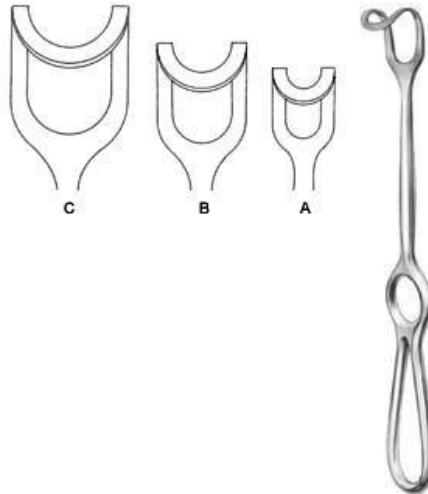
22 cm 42 x 10 mm, 22 cm 42 x 15 mm, 22 cm 43 x 20 mm,

Middeldorpf
JU-5-951-01

Retractor

21.5 cm 18 x 17 mm, 23 cm 25 x 22 mm, 24.5 cm 30 x 31 mm,

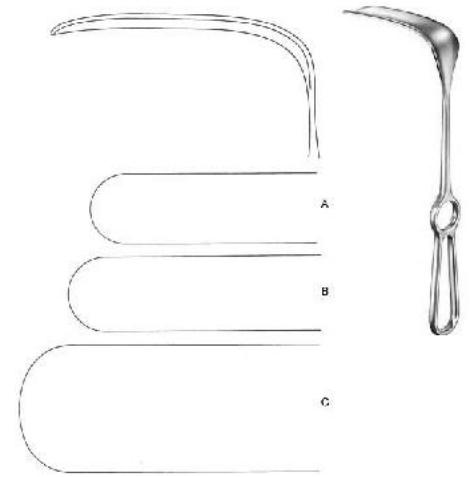
Doyen-Stille
JU-5-952-01

Retractor

26 cm 97 x 29 mm, 26 cm 101 x 31 mm, 26 cm 127 x 52 mm,

Hosel
JU-5-953-01

Retractor

26 cm 63 x 21 mm, 26 cm 83 x 30 mm, 26 cm 103 x 30 mm, 26 cm 120 x 30 mm, 26 cm 140 x 30 mm, 26 cm 140 x 40 mm,

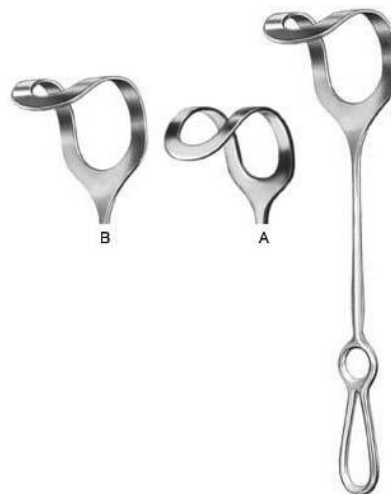
Middeldorpf
JU-5-954-01

Retractor

27 cm 48 x 45 mm, 27 cm 52 x 50 mm, 27 cm 60 x 70 mm,

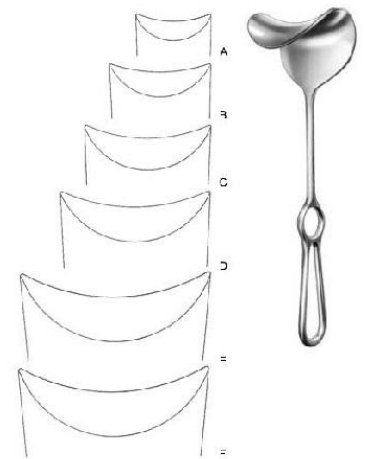
Fritsch
JU-5-955-00

Retractor

23.5 cm 37 x 31 mm, 24 cm 38 x 40 mm, 25 cm 43 x 51 mm, 25 cm 49 x 61 mm, 25.5 cm 48 x 75 mm, 25.5 cm 65 x 85 mm,

Retractors

Doyen
JU-5-956-25
 Retractor
 24 cm 48 x 88 mm,



Kocher
JU-5-957-22
 Retractor
 24 cm 73 x 25 mm,



Kocher
JU-5-958-01
 Retractor
 25 cm 80 x 45 mm, 25 cm 80 x 55 mm, 25 cm
 80 x 65 mm,



Martin
JU-5-959-25
 Retractor
 26 cm 110 x 27 mm,

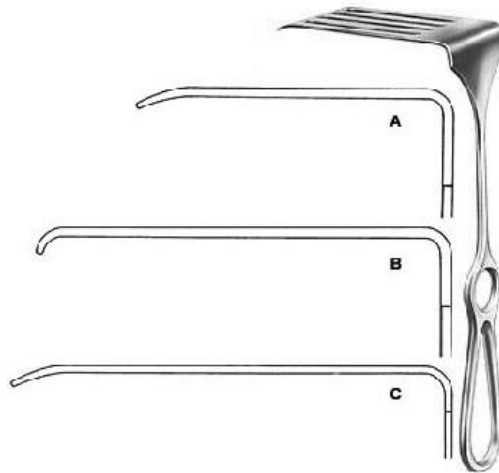

Coryllos
JU-5-960-01
 Retractor
 24 cm 85 x 22 mm, 24 cm 108 x 43 mm, 24
 cm 119 x 65 mm,

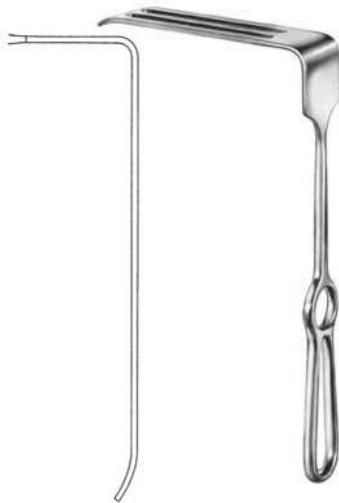

Davidson
JU-5-961-01
 Retractor
 19 cm 80 x 54 mm, 18.5 cm 80 x 95 mm,

Retractors

Sauerbruch
JU-5-962-25

Retractor
25.5 cm 127 x 38 mm,

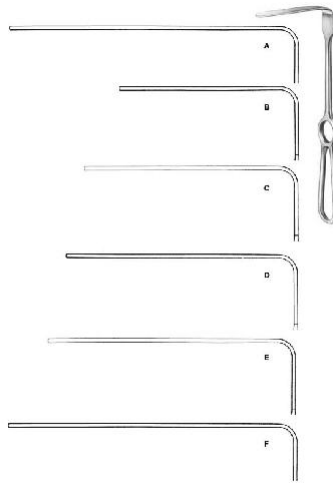

Brunner
JU-5-963-08

Retractor
25.5 cm 84 x 20 mm, 25.5 cm 104 x 25 mm, 25.5 cm 124 x 30 mm, 25.5 cm 130 x 30 mm, 25.5 cm 144 x 30 mm, 25.5 cm 160 x 30 mm, 25.5 cm 164 x 30 mm,

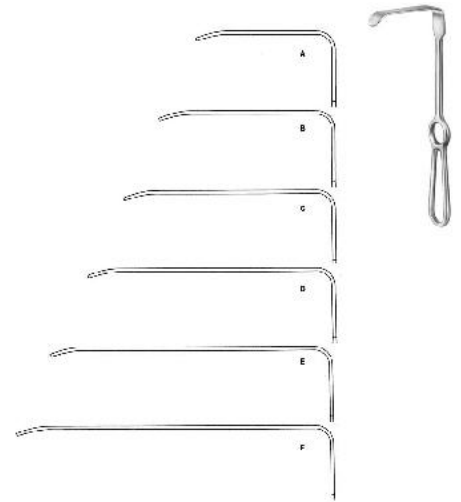

Brunner
JU-5-964-08

Retractor
25.5 cm 82 x 20 mm, 25.5 cm 102 x 20 mm, 25.5 cm 122 x 25 mm, 25.5 cm 140 x 25 mm, 25.5 cm 162 x 30 mm, 25.5 cm 182 x 30 mm,

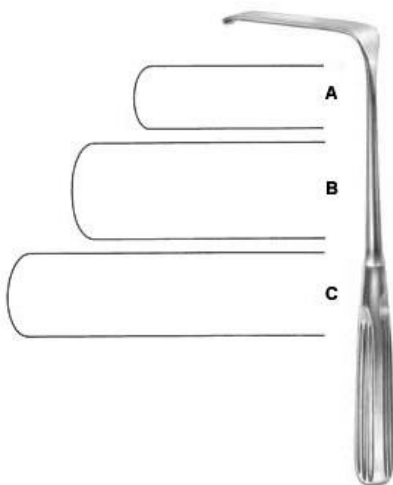

Sauerbruch
JU-5-965-01

Retractor
22.5 cm 50 x 15mm, 22.5 cm 63 x 23mm, 22.5 cm 80 x 20mm,



Deaver
JU-5-966-01

Retractor
18 cm 19mm,

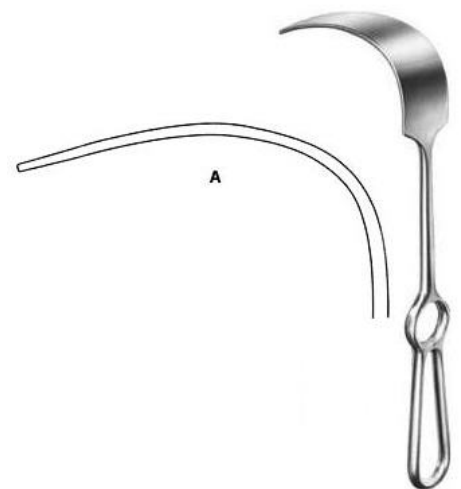

Mikulicz
JU-5-968-01

Retractor
25 cm 90 x 35mm, 25 cm 125 x 50mm, 25 cm 160 x 50mm,

Retractors

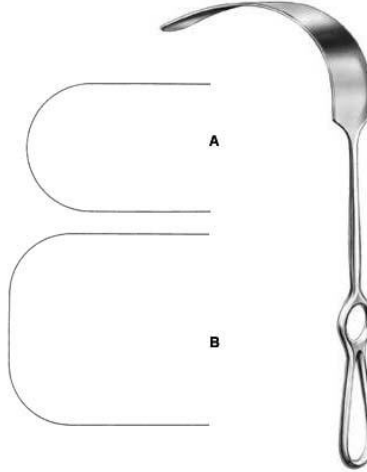

Mikulicz
JU-5-969-26
 Retractor
 26 cm 90 x 55mm,



Kelly
JU-5-970-01
 Retractor
 27.5 cm 205 x 38mm, 27.5 cm 205 x 57mm,

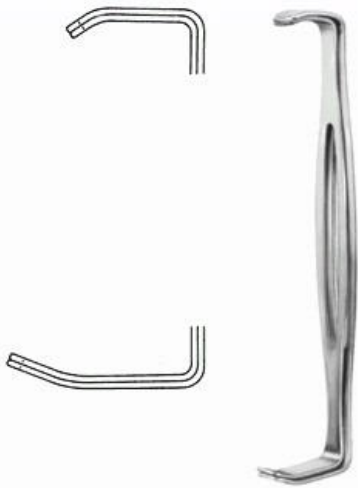

Farabeuf
JU-5-971-00
 Retractor
 15 cm Fig. 1 = 23 x 16, 15 cm Fig. 1 = 26 x 16, 15 cm Fig. 2 = 27 x 16, 15 cm Fig. 2 = 30 x 16,



Parker-Langenbeck
JU-5-972-00
 Retractor
 21.5 cm Fig. 1 = 21x15mm, 21.5 cm Fig. 1 = 40x15mm, 21.5 cm Fig. 2 = 25x15mm, 21.5 cm Fig. 2 = 45x15mm,



Alm
JU-5-973-07
 Wound Spreaders, self-retaining
 7 cm,



Alm
JU-5-974-07
 Wound Spreaders, self-retaining
 7 cm,

Retractors

Gosset
JU-5-975-22
 Abdominal Retractor
 18.5 cm,



Balfour-Baby
JU-5-976-00
 Abdominal Retractor spreading 90mm, 1
 central blade 24 x 20mm
 12.5 cm,



Balfour
JU-5-977-00
 Abdominal Retractor spreading 180mm,
 lateral blades 70 x 35mm, 1 central blade
 20 cm,



Deaver
JU-5-967-04
 Retractor
 31.5 cm 25mm, 31.5 cm 38mm, 31.5 cm
 50mm, 31.5 cm 100mm,

Probes

JU-5-1001-11

Probe

11.5 cm, 13 cm, 14.5 cm, 16 cm, 18 cm, 20 cm, 25 cm, 30 cm,

JU-5-1002-11

Probe

11.5 cm, 13 cm, 14.5 cm, 16 cm, 18 cm, 20 cm, 25 cm, 30 cm,

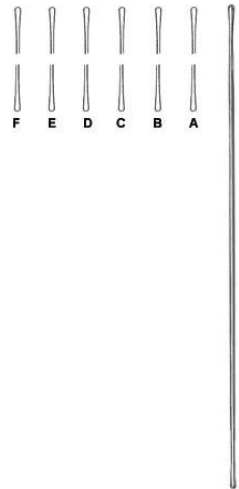
JU-5-1003-13

Probe

13 cm, 14.5 cm, 16 cm, 18 cm, 20 cm, 25 cm,

JU-5-1004-13

Probe with eye

13 cm, 14.5 cm, 16 cm,

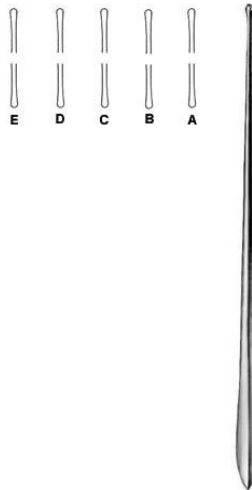
JU-5-1006-13

Myrtle Leaf Probe

13 cm, 14.5 cm, 16 cm, 18 cm, 20 cm,

JU-5-1007-13

Grooved Director

13 cm, 14 cm, 16 cm,

Probes



JU-5-1008-13
Grooved Director
13 cm, 14.5 cm, 16 cm,



Doyen
JU-5-1009-14
Grooved Director
14.5 cm,

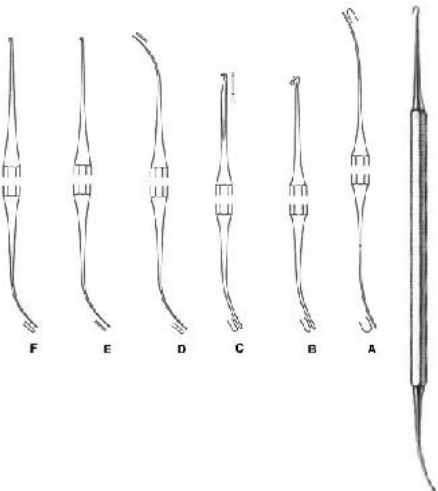

Nelaton
JU-5-1010-16
Grooved Director
16 cm,

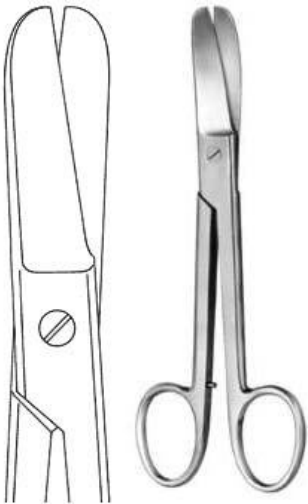

Varady
JU-5-1011-01
Phlebodissector
18 cm, 17.5 cm,

Plaster

Lorenz
JU-6-101-23

 Bandage Scissors heavy pattern
23 cm,

Lister
JU-6-102-14

 Bandage Scissors
14.5 cm, 18.5 cm, 20 cm,

Bergmann
JU-6-103-23

 Plaster Shears
23.5 cm,

Esmarch
JU-6-104-20

 Plaster Shears heavy pattern, short blades
20 cm,

JU-6-105-15

 Bandage Scissors black plastic ring with
autodavable
16 cm, 19 cm,

JU-6-106-18

 Bandage Scissors black plastic rings
19 cm, 16 cm,

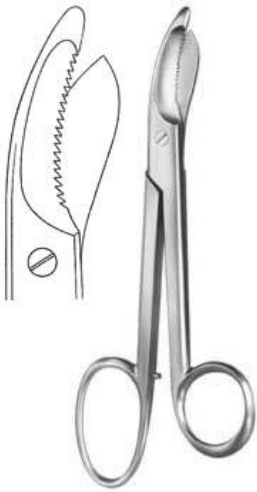
Plaster

Bruns
JU-6-107-24
 Plaster Scissors
 24 cm,

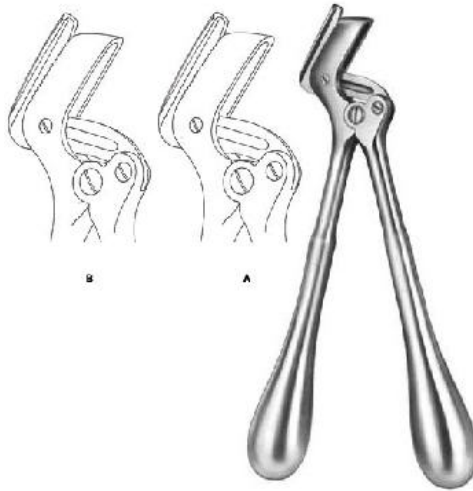

Stille-Martin
JU-6-108-23
 Plaster Shears
 23 cm, 27 cm, 38 cm,

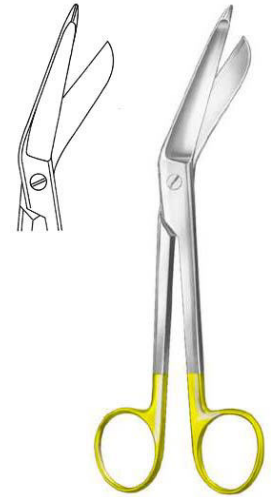

Lister
JU-6-109-18
 Bandage Scissors
 18 cm,

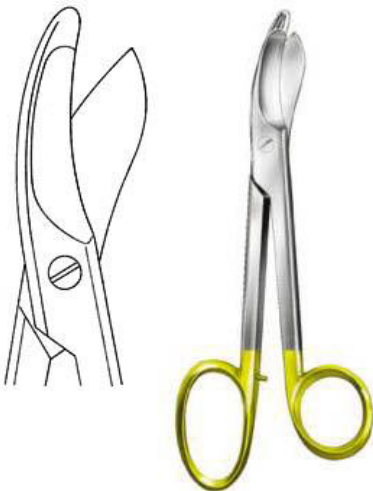

Bruns
JU-6-110-24
 Plaster Scissors
 24 cm,



Hopkins
JU-6-111-20
 Plaster Knife with wooden handle
 20 cm,



Reiner
JU-6-112-18
 Plaster Knife
 18 cm,

Plaster



Reiner
JU-6-113-18
 Plaster Knife
 18 cm,



Martin
JU-6-114-21
 Plaster Knife with wooden handle
 21 cm,

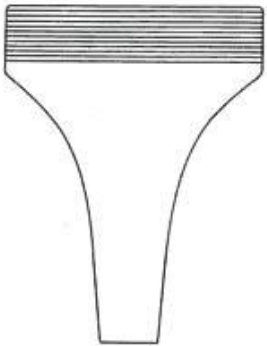

Engel
JU-6-115-14
 Plaster Saw
 15.5 cm,



Hennig
JU-6-116-28
 Plaster Spreader
 28 cm,

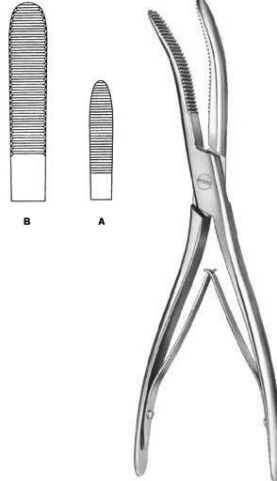

Wolff
JU-6-117-18
 Plaster Breaker
 18 cm, 26.5 cm,

Neurosurgery



Gigli
JU-8-101-01
Wire Saw Handle



De Martel
JU-8-102-33
Wire Saw Guide
33 cm,



Crutchfield
JU-8-103-01
Skull Traction Tong small pattern



JU-8-104-01
Skull Traction Tong large pattern
22.5 cm,



Dahlgren
JU-8-105-20
Cranial Rongeur
20 cm,



Olivecrona-Toennis
JU-8-106-14
Clip Applying Forceps

Neurosurgery



McKenzie
JU-8-107-19
Clip Applying Forceps
18.5 cm,



Olivecrona
JU-8-108-18
Dura Dissector
18 cm,



Olivecrona
JU-8-109-19
Dura Dissector
20 cm,



Milligan
JU-8-110-21
Dura Dissector
21.5 cm,



Davis
JU-8-111-21
Dura Dissector sharp
21.5 cm,



JU-8-112-22
Dura Dissector
22 cm,

Neurosurgery

Davis
JU-8-113-24
 Dura Dissector
 24.5 cm,



Love
JU-8-114-19
 Nerve Root Retractor
 21.5 cm, 18 cm, 11 cm,



Olivecrona
JU-8-115-18
 Brain Spatula
 18 cm,



Scoville
JU-8-116-23
 Nerve Root Retractor 8mm
 23.5 cm,



Holsher
JU-8-117-24
 Nerve Root Retractor 8mm
 23.5 cm,

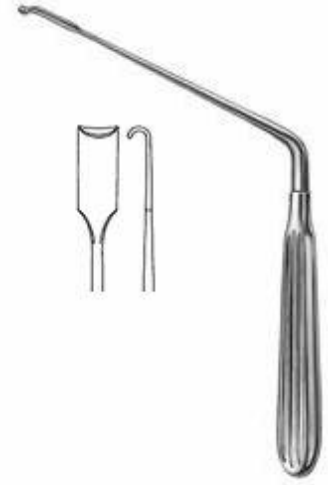

Scoville
JU-8-118-19
 Nerve Root Retractor 7mm
 16.5 cm,

Neurosurgery



Groningen
JU-8-119-26
 Nerve Hook
 26.5 cm,



Groningen
JU-8-120-26
 Nerve Hook
 26.5 cm,

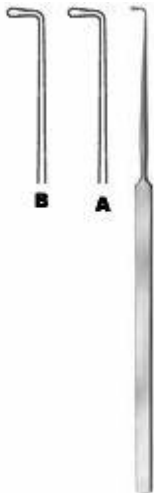

Cushing
JU-8-121-19
 Nerve Hook blunt
 19 cm, 28 cm,



Cushing
JU-8-122-19
 Nerve Hook
 19.5 cm, 28 cm,



Smithwick
JU-8-123-17
 Nerve Hook
 17 cm, 21 cm,



Halle
JU-8-125-20
 Dura Knife
 20 cm,

Neurosurgery

Adson
JU-8-126-20
 Dura Hook
 20 cm,



Graham
JU-8-127-16
 Dura Hook blunt
 16.5 cm,



Sachs
JU-8-128-18
 Dura Hook sharp
 18 cm,



Toennis
JU-8-129-15
 Dura Hook sharp
 14.5 cm,



Frazier
JU-8-130-13
 Dura Hook sharp
 13 cm, 18 cm,



Krayenbuhl
JU-8-131-01
 Nerve and Vessel Hooklet
 18.5 cm Fig. 1, 18.5 cm Fig. 2,

Neurosurgery

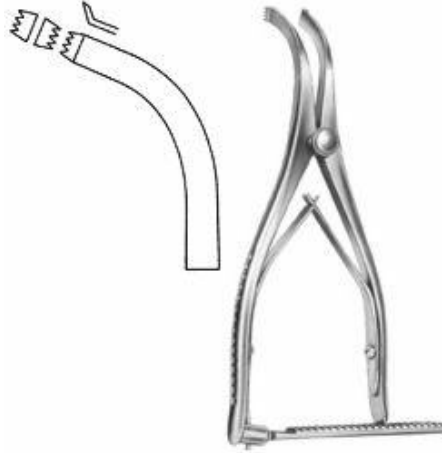

Cloward
JU-8-132-16
 Lamina Spreader
 16 cm,

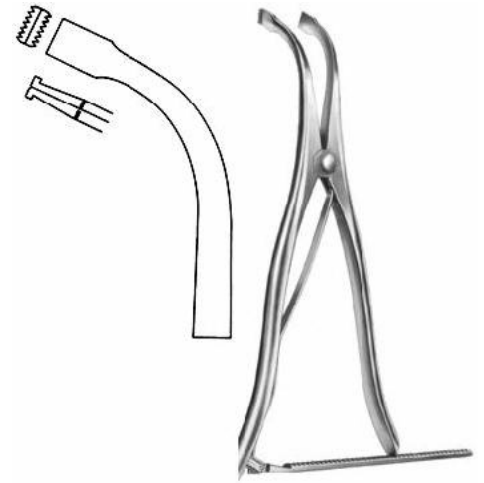

Inge
JU-8-133-17
 Lamina Spreader
 16 cm,

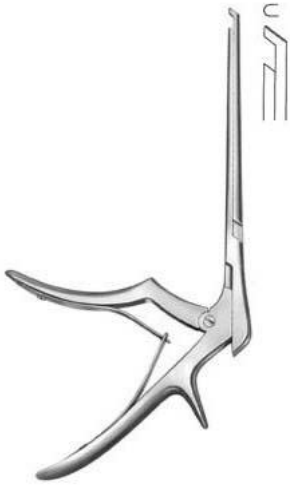

Inge
JU-8-134-27
 Lamina Spreader
 25.5 cm,



Ferris-Smith Kerrison
JU-8-135-03
 Laminectomy Punch 3mm downwards
 cutting 40 degree shaft length 180 mm

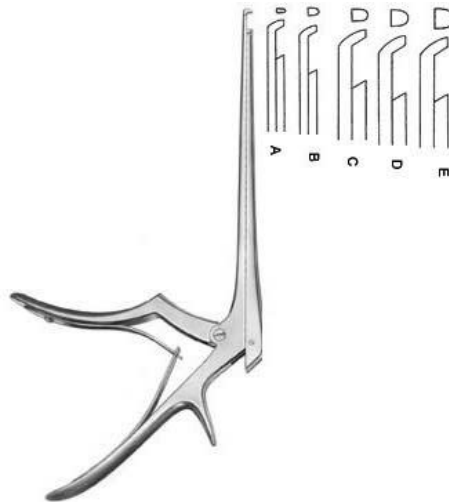

Ferris-Smith Kerrison
JU-8-138-01
 Laminectomy Punch upwards cutting shaft
 length 180 mm
 1 mm, 2 mm, 3 mm, 4 mm, 5 mm, 6 mm,

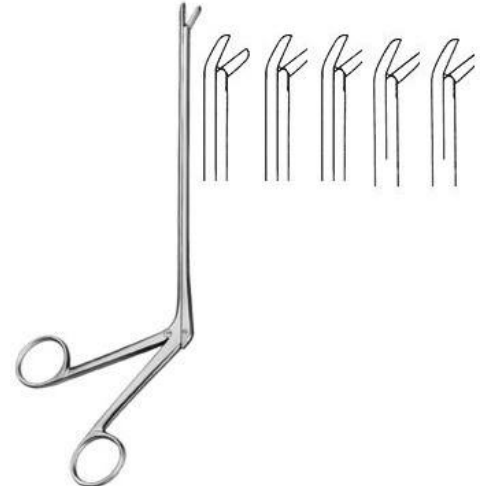

Cushing
JU-8-139-01
 Laminectomy Rongeur jaw 2 x 10 to 4 x 10
 mm straight shaft length 180 mm

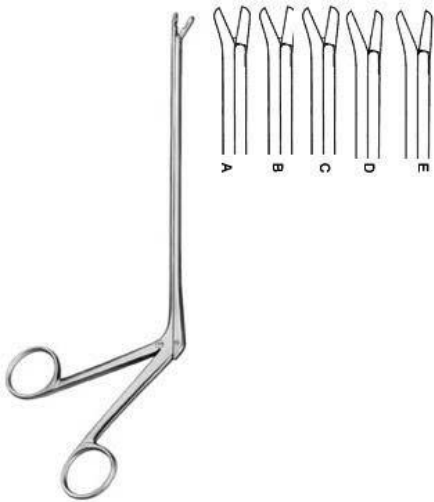

Cushing
JU-8-140-01

Laminectomy Rongeur jaw 2 x 10 to 4 x 10 mm upwards 45 degree shaft length 120 mm

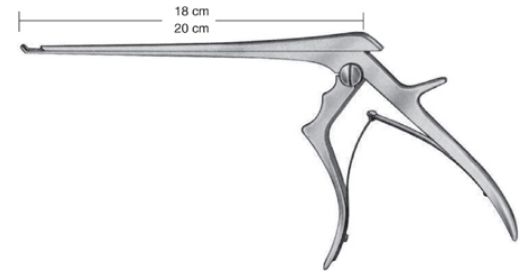
Ferris-Smith Kerrison
JU-8-137-01

 Laminectomy Punch
 1 mm, 2 mm, 3 mm, 4 mm, 5 mm, 6 mm,

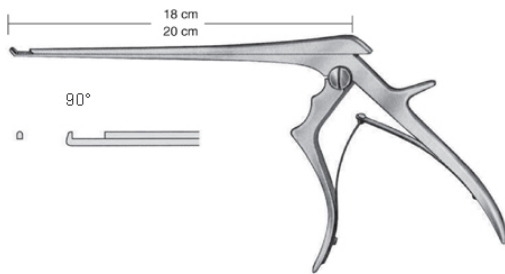
FERRIS-SMITH-KERRISON
JU-9-137-01

with thin footplate

FERRIS-SMITH-KERRISON
JU-9-137-02

With thin footplate

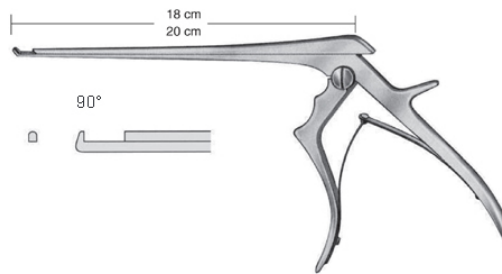
18 cm , 20 cm , 1mm , 2 mm , 3 mm , 4 mm , 5 mm,

FERRIS-SMITH-KERRISON
JU-9-137-03

With thin footplate

18 cm , 20 cm , 1mm , 2 mm , 3 mm , 4 mm , 5 mm,

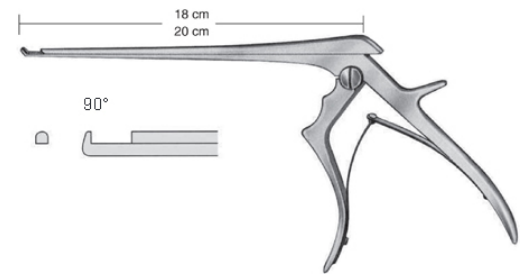
FERRIS-SMITH-KERRISON
JU-9-137-04

With thin footplate

18 cm , 20 cm , 1mm , 2 mm , 3 mm , 4 mm , 5 mm,

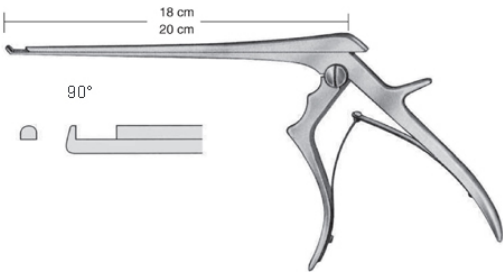
FERRIS-SMITH-KERRISON
JU-9-137-05

With thin footplate

18 cm , 20 cm , 1mm ,2 mm,3 mm ,4 mm ,5 mm,

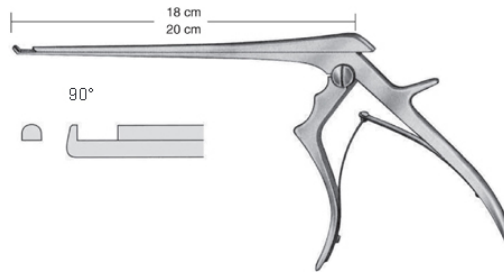
FERRIS-SMITH-KERRISON
JU-9-137-06

With thin footplate

18 cm , 20 cm , 1mm ,2 mm,3 mm ,4 mm ,5 mm,

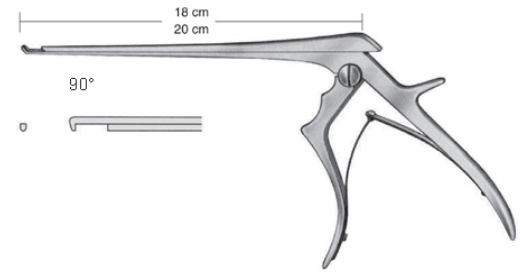
FERRIS-SMITH-KERRISON
JU-9-137-07

with thin footplate

18 cm , 20 cm , 1 mm,2 mm,3 mm,4 mm,5 mm,

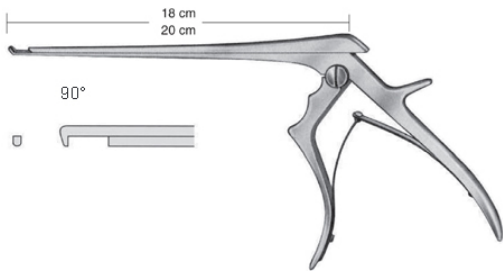
FERRIS-SMITH-KERRISON
JU-9-137-08

with thin footplate

18 cm , 20 cm , 1 mm,2 mm,3 mm,4 mm,5 mm,

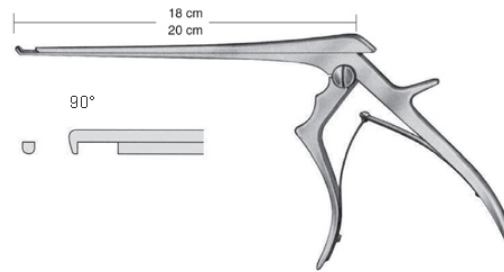
FERRIS-SMITH-KERRISON
JU-9-137-09

with thin footplate

18 cm , 20 cm , 1 mm,2 mm,3 mm,4 mm,5 mm,

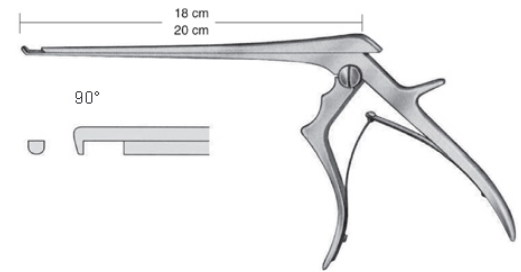
FERRIS-SMITH-KERRISON
JU-9-137-10

with thin footplate

18 cm , 20 cm , 1 mm,2 mm,3 mm,4 mm,5 mm,

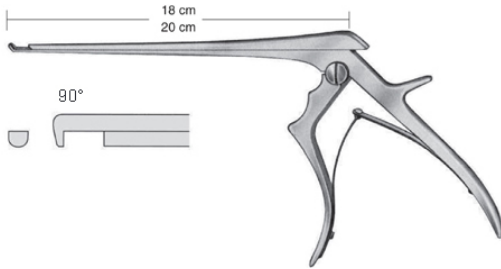
FERRIS-SMITH-KERRISON
JU-9-137-11

with thin footplate

18 cm , 20 cm , 1 mm,2 mm,3 mm,4 mm,5 mm,

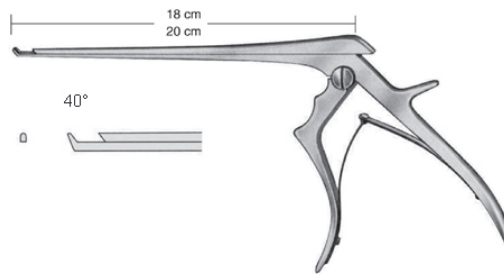
FERRIS-SMITH-KERRISON
JU-9-137-12

with thin footplate

1 mm,2 mm,3 mm,4 mm,5 mm,

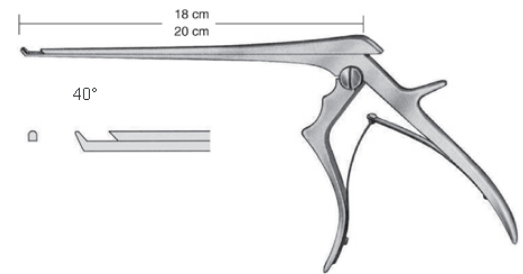
FERRIS-SMITH-KERRISON
JU-9-137-13

with thin footplate

1 mm,2 mm,3 mm,4 mm,5 mm,

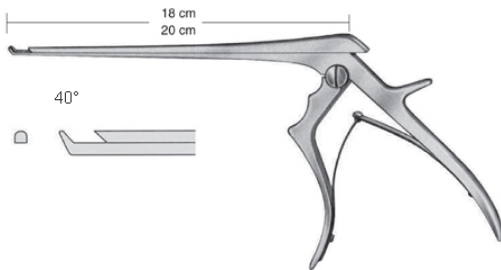
FERRIS-SMITH-KERRISON
JU-9-137-14

with thin footplate

1 mm,2 mm,3 mm,4 mm,5 mm,

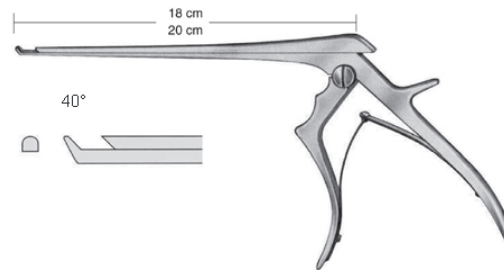
FERRIS-SMITH-KERRISON
JU-9-137-15

with thin footplate

1 mm,2 mm,3 mm,4 mm,5 mm,

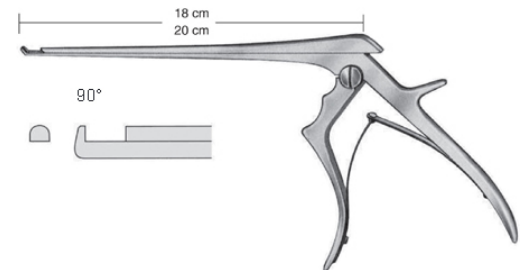

FERRIS-SMITH-KERRISON
JU-9-137-16

with thin footplate

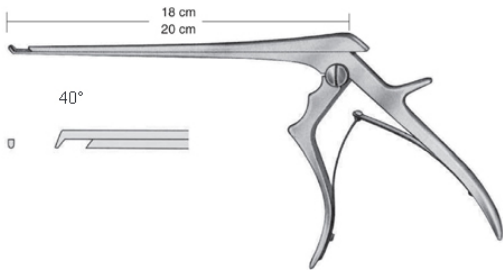
1 mm,2 mm,3 mm,4 mm,5 mm,

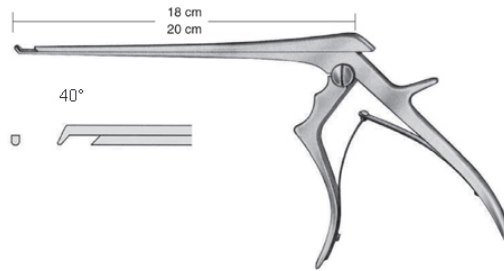

FERRIS-SMITH-KERRISON
JU-9-137-17
 with thin footplate
 1 mm, 2 mm, 3 mm, 4 mm, 5 mm,



FERRIS-SMITH-KERRISON
JU-9-137-18
 with thin footplate
 1 mm, 2 mm, 3 mm, 4 mm, 5 mm,

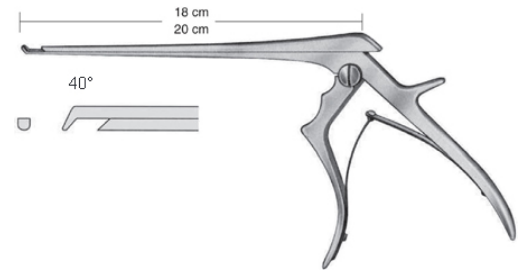

FERRIS-SMITH-KERRISON
JU-9-137-19
 with thin footplate
 1 mm, 2 mm, 3 mm, 4 mm, 5 mm,

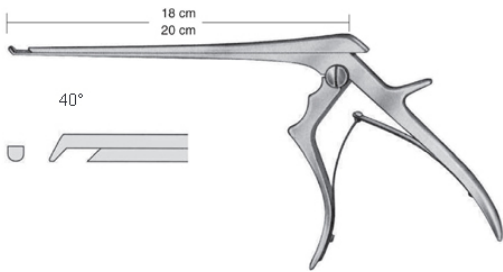

FERRIS-SMITH-KERRISON
JU-9-137-20
 with thin footplate
 1 mm, 2 mm, 3 mm, 4 mm, 5 mm,

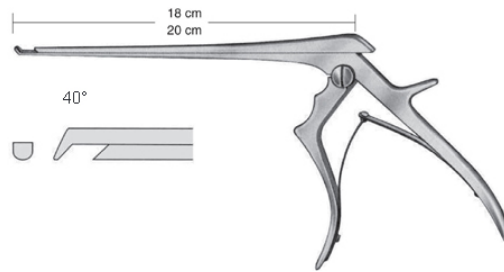

FERRIS-SMITH-KERRISON
JU-9-137-21
 with thin footplate
 1 mm, 2 mm, 3 mm, 4 mm, 5 mm,

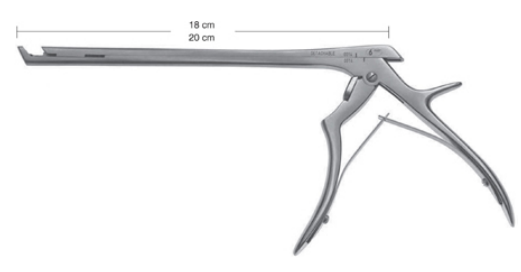

JU-9-137-22
 18 cm, 20 cm ,

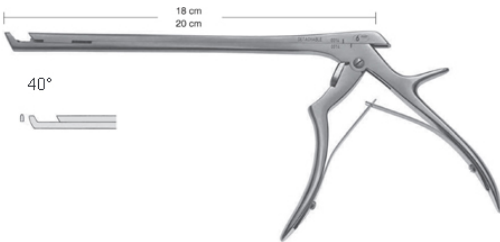
Neurosurgery

JU-9-137-23

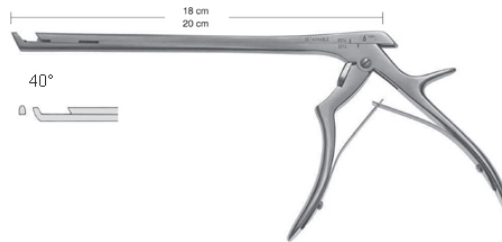
18 cm , 20 cm , 1mm,2 mm,3 mm,4 mm,5 mm,6 mm,

JU-9-137-24

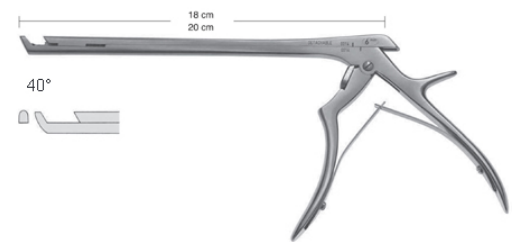
18 cm , 20 cm , 1mm,2 mm,3 mm,4 mm,5 mm,6 mm,

JU-9-137-25

18 cm , 20 cm , 1mm,2 mm,3 mm,4 mm,5 mm,6 mm,

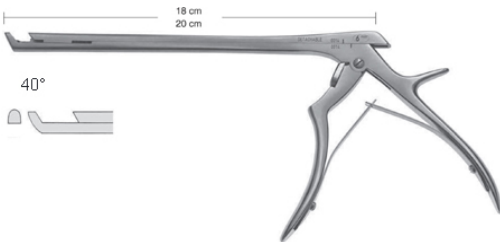
JU-9-137-26

18 cm , 20 cm , 1mm,2 mm,3 mm,4 mm,5 mm,6 mm,

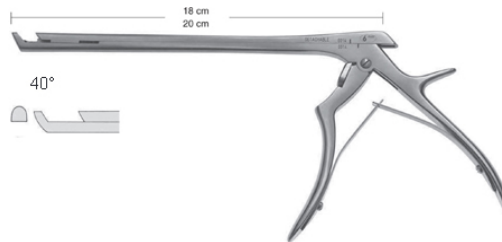
JU-9-137-27

18 cm , 20 cm , 1mm,2 mm,3 mm,4 mm,5 mm,6 mm,

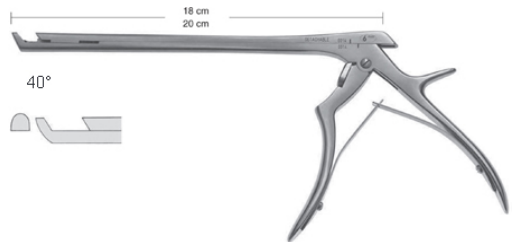
JU-9-137-28

18 cm , 20 cm , 1mm,2 mm,3 mm,4 mm,5 mm,6 mm,

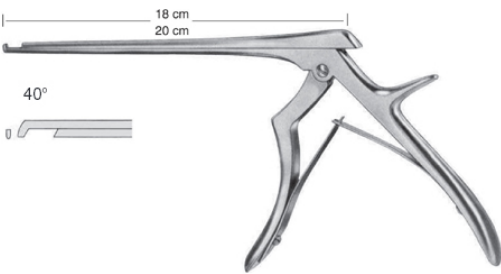
Neurosurgery

JU-9-137-29

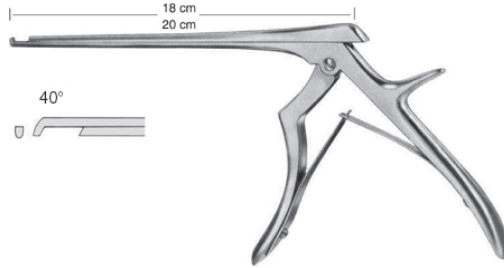
18 cm , 20 cm , 1mm,2 mm,3 mm,4 mm,5 mm,6 mm,

JU-9-137-30

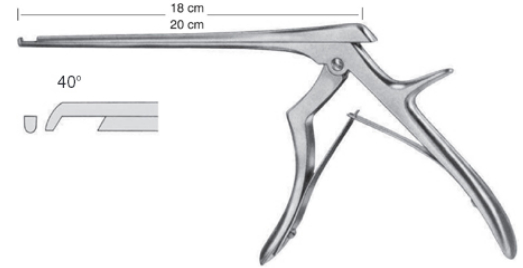
18 cm , 20 cm , 1mm,2 mm,3 mm,4 mm,5 mm,6 mm,

JU-9-137-31

18 cm , 20 cm , 1mm,2 mm,3 mm,4 mm,5 mm,6 mm,

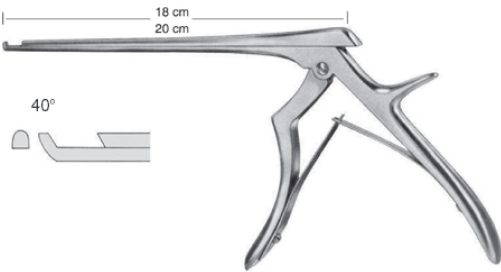
JU-9-137-32

18 cm , 20 cm , 1mm,2 mm,3 mm,4 mm,5 mm,6 mm,

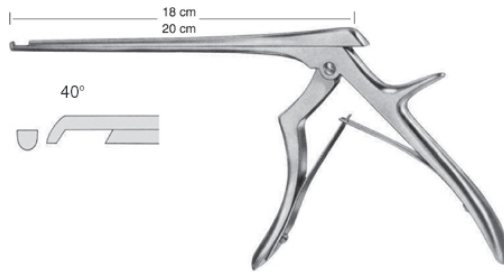
JU-9-137-33

18 cm , 20 cm , 1mm,2 mm,3 mm,4 mm,5 mm,6 mm,

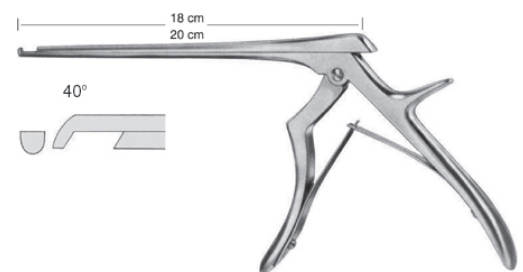
JU-9-137-34

18 cm , 20 cm , 1mm,2 mm,3 mm,4 mm,5 mm,6 mm,

Neurosurgery

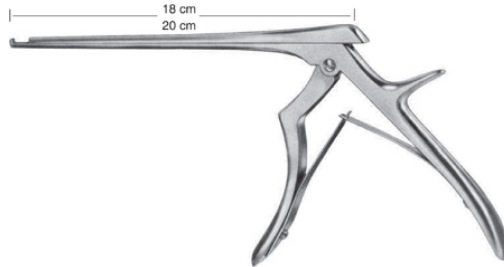

detachable
JU-9-137-35
detachable

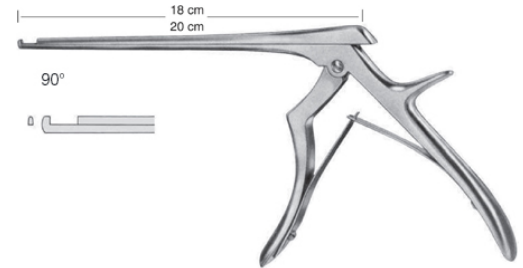

FERRIS-SMITH-KERRISON
JU-9-137-36
FERRIS-SMITH-KERRISON

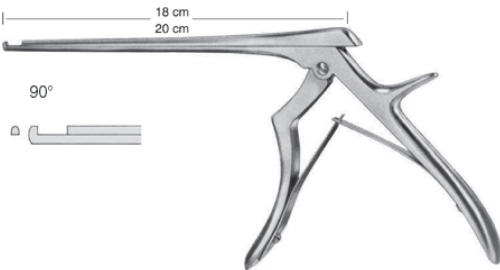

FERRIS-SMITH-KERRISON
JU-9-137-37
FERRIS-SMITH-KERRISON
18 cm , 20 cm ,
1mm,2mm,3mm,4mm,5mm,6mm,



FERRIS-SMITH-KERRISON
JU-9-137-38

FERRIS-SMITH-KERRISON
18 cm , 20 cm , 1mm,18 cm , 20 cm ,
2mm,18 cm , 20 cm , 3mm,18 cm , 20 cm ,
4mm,18 cm , 20 cm , 5mm,18 cm , 20 cm ,
6mm,

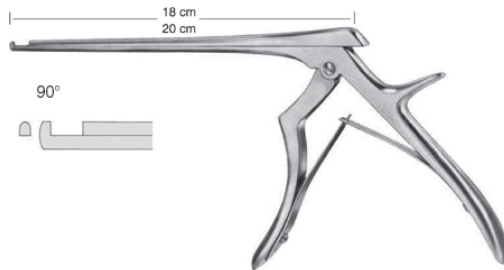

FERRIS-SMITH-KERRISON
JU-9-137-39

FERRIS-SMITH-KERRISON
18 cm , 20 cm , 1mm,18 cm , 20 cm ,
2mm,18 cm , 20 cm , 3mm,18 cm , 20 cm ,
4mm,18 cm , 20 cm , 5mm,18 cm , 20 cm ,
6mm,

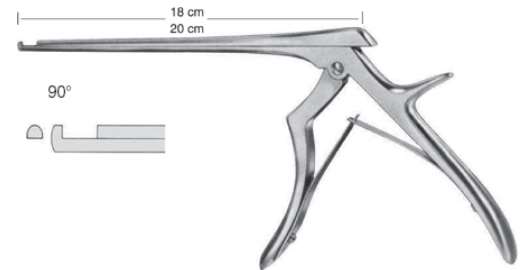

FERRIS-SMITH-KERRISON
JU-9-137-40

FERRIS-SMITH-KERRISON
18 cm , 20 cm , 1mm,18 cm , 20 cm ,
2mm,18 cm , 20 cm , 3mm,18 cm , 20 cm ,
4mm,18 cm , 20 cm , 5mm,18 cm , 20 cm ,
6mm,

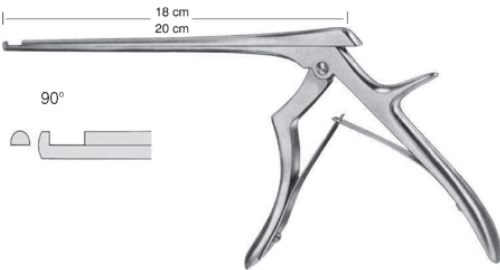
FERRIS-SMITH-KERRISON
JU-9-137-41
FERRIS-SMITH-KERRISON

18 cm , 20 cm , 1mm,18 cm , 20 cm ,
2mm,18 cm , 20 cm , 3mm,18 cm , 20 cm ,
4mm,18 cm , 20 cm , 5mm,18 cm , 20 cm ,
6mm,

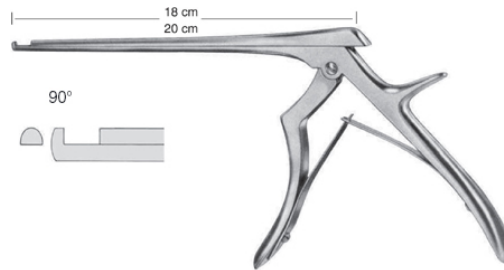
FERRIS-SMITH-KERRISON
JU-9-137-42
FERRIS-SMITH-KERRISON

18 cm , 20 cm , 1mm,18 cm , 20 cm ,
2mm,18 cm , 20 cm , 3mm,18 cm , 20 cm ,
4mm,18 cm , 20 cm , 5mm,18 cm , 20 cm ,
6mm,

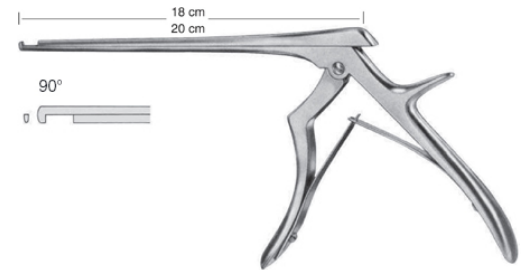
FERRIS-SMITH-KERRISON
JU-9-137-43
FERRIS-SMITH-KERRISON

18 cm , 20 cm , 1mm,18 cm , 20 cm ,
2mm,18 cm , 20 cm , 3mm,18 cm , 20 cm ,
4mm,18 cm , 20 cm , 5mm,18 cm , 20 cm ,
6mm,

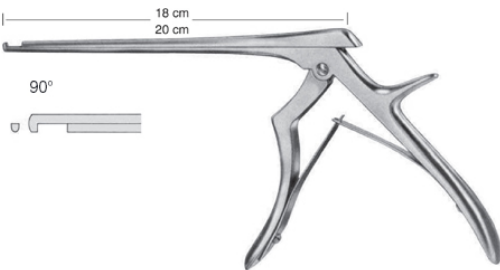
FERRIS-SMITH-KERRISON
JU-9-137-44
FERRIS-SMITH-KERRISON

18 cm , 20 cm , 1mm,18 cm , 20 cm ,
2mm,18 cm , 20 cm , 3mm,18 cm , 20 cm ,
4mm,18 cm , 20 cm , 5mm,18 cm , 20 cm ,
6mm,

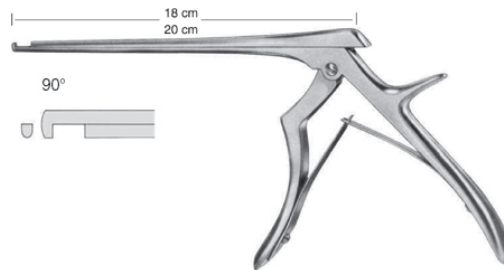
FERRIS-SMITH-KERRISON
JU-9-137-45
FERRIS-SMITH-KERRISON

18 cm , 20 cm , 1mm,18 cm , 20 cm ,
2mm,18 cm , 20 cm , 3mm,18 cm , 20 cm ,
4mm,18 cm , 20 cm , 5mm,18 cm , 20 cm ,
6mm,

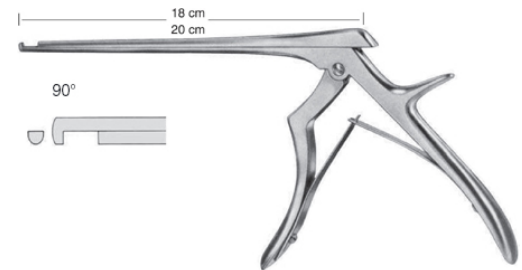
FERRIS-SMITH-KERRISON
JU-9-137-46
FERRIS-SMITH-KERRISON

18 cm , 20 cm , 1mm,18 cm , 20 cm ,
2mm,18 cm , 20 cm , 3mm,18 cm , 20 cm ,
4mm,18 cm , 20 cm , 5mm,18 cm , 20 cm ,
6mm,

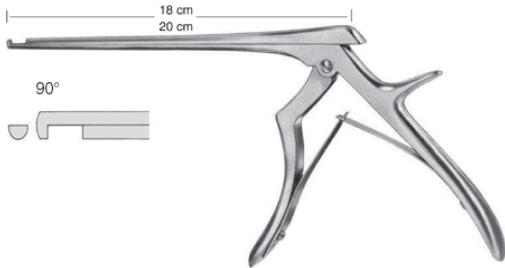
FERRIS-SMITH-KERRISON
JU-9-137-47
FERRIS-SMITH-KERRISON

18 cm , 20 cm , 1mm,18 cm , 20 cm ,
2mm,18 cm , 20 cm , 3mm,18 cm , 20 cm ,
4mm,18 cm , 20 cm , 5mm,18 cm , 20 cm ,
6mm,

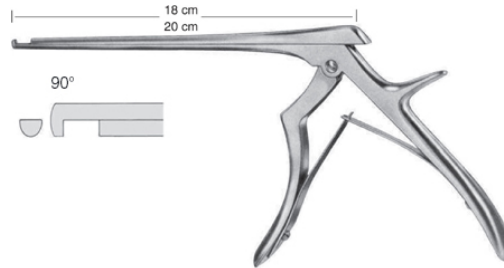
FERRIS-SMITH-KERRISON
JU-9-137-48
FERRIS-SMITH-KERRISON

18 cm , 20 cm , 1mm,18 cm , 20 cm ,
2mm,18 cm , 20 cm , 3mm,18 cm , 20 cm ,
4mm,18 cm , 20 cm , 5mm,18 cm , 20 cm ,
6mm,

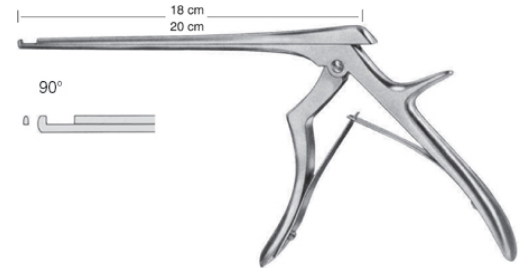
FERRIS-SMITH-KERRISON
JU-9-137-49
FERRIS-SMITH-KERRISON

18 cm , 20 cm , 1mm,18 cm , 20 cm ,
2mm,18 cm , 20 cm , 3mm,18 cm , 20 cm ,
4mm,18 cm , 20 cm , 5mm,18 cm , 20 cm ,
6mm,

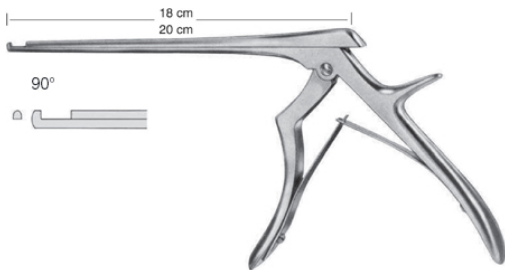
FERRIS-SMITH-KERRISON
JU-9-137-50
FERRIS-SMITH-KERRISON

18 cm , 20 cm , 1mm,18 cm , 20 cm ,
2mm,18 cm , 20 cm , 3mm,18 cm , 20 cm ,
4mm,18 cm , 20 cm , 5mm,18 cm , 20 cm ,
6mm,

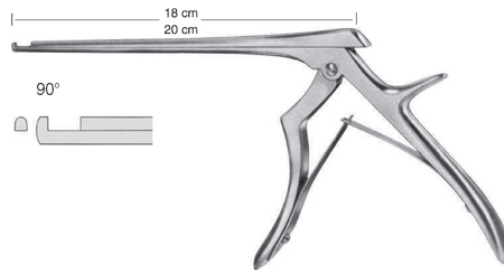
FERRIS-SMITH-KERRISON
JU-9-137-51
FERRIS-SMITH-KERRISON

18 cm , 20 cm , 1mm,18 cm , 20 cm ,
2mm,18 cm , 20 cm , 3mm,18 cm , 20 cm ,
4mm,18 cm , 20 cm , 5mm,18 cm , 20 cm ,
6mm,

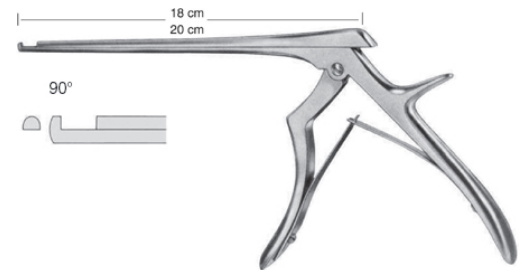
FERRIS-SMITH-KERRISON
JU-9-137-52
FERRIS-SMITH-KERRISON

18 cm , 20 cm , 1mm,18 cm , 20 cm ,
2mm,18 cm , 20 cm , 3mm,18 cm , 20 cm ,
4mm,18 cm , 20 cm , 5mm,18 cm , 20 cm ,
6mm,

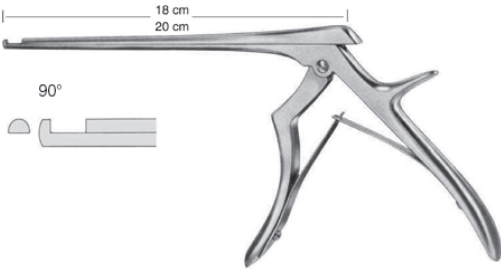
Neurosurgery

FERRIS-SMITH-KERRISON
JU-9-137-53
FERRIS-SMITH-KERRISON

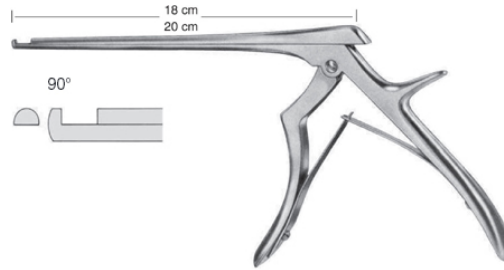
18 cm , 20 cm , 1mm,18 cm , 20 cm ,
2mm,18 cm , 20 cm , 3mm,18 cm , 20 cm ,
4mm,18 cm , 20 cm , 5mm,18 cm , 20 cm ,
6mm,

FERRIS-SMITH-KERRISON
JU-9-137-54
FERRIS-SMITH-KERRISON

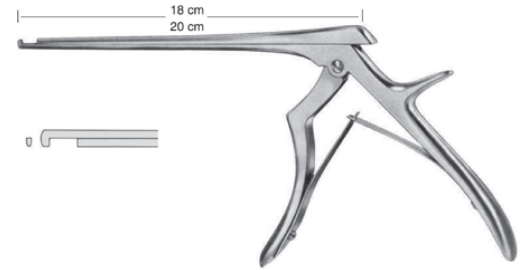
18 cm , 20 cm , 1mm,18 cm , 20 cm ,
2mm,18 cm , 20 cm , 3mm,18 cm , 20 cm ,
4mm,18 cm , 20 cm , 5mm,18 cm , 20 cm ,
6mm,

FERRIS-SMITH-KERRISON
JU-9-137-55
FERRIS-SMITH-KERRISON

18 cm , 20 cm , 1mm,18 cm , 20 cm ,
2mm,18 cm , 20 cm , 3mm,18 cm , 20 cm ,
4mm,18 cm , 20 cm , 5mm,18 cm , 20 cm ,
6mm,

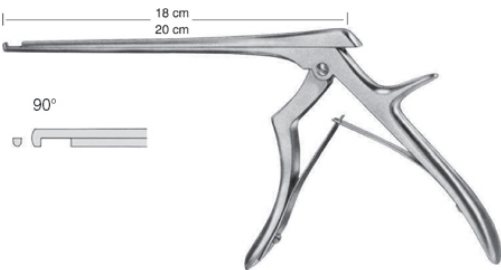
FERRIS-SMITH-KERRISON
JU-9-137-56
FERRIS-SMITH-KERRISON

18 cm , 20 cm , 1mm,18 cm , 20 cm ,
2mm,18 cm , 20 cm , 3mm,18 cm , 20 cm ,
4mm,18 cm , 20 cm , 5mm,18 cm , 20 cm ,
6mm,

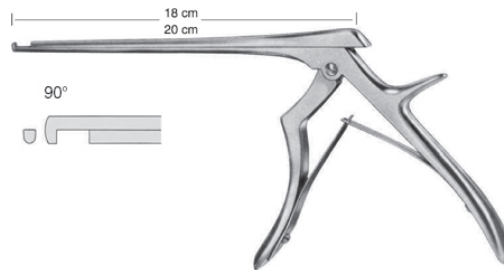
FERRIS-SMITH-KERRISON
JU-9-137-57
FERRIS-SMITH-KERRISON

18 cm , 20 cm , 1mm,18 cm , 20 cm ,
2mm,18 cm , 20 cm , 3mm,18 cm , 20 cm ,
4mm,18 cm , 20 cm , 5mm,18 cm , 20 cm ,
6mm,

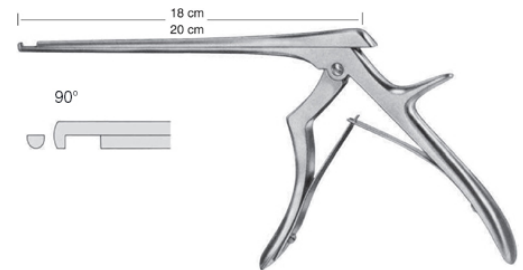
FERRIS-SMITH-KERRISON
JU-9-137-58
FERRIS-SMITH-KERRISON

18 cm , 20 cm , 1mm,18 cm , 20 cm ,
2mm,18 cm , 20 cm , 3mm,18 cm , 20 cm ,
4mm,18 cm , 20 cm , 5mm,18 cm , 20 cm ,
6mm,

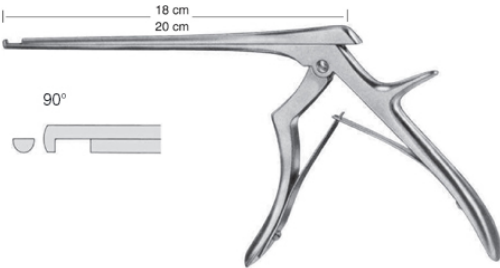
FERRIS-SMITH-KERRISON
JU-9-137-59
FERRIS-SMITH-KERRISON

18 cm , 20 cm , 1mm,18 cm , 20 cm ,
2mm,18 cm , 20 cm , 3mm,18 cm , 20 cm ,
4mm,18 cm , 20 cm , 5mm,18 cm , 20 cm ,
6mm,

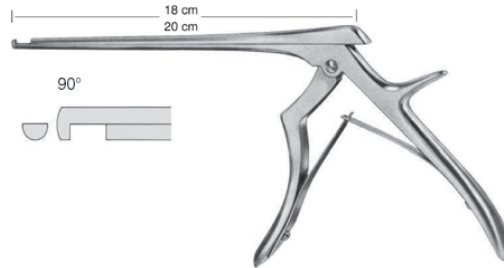
FERRIS-SMITH-KERRISON
JU-9-137-60
FERRIS-SMITH-KERRISON

18 cm , 20 cm , 1mm,18 cm , 20 cm ,
2mm,18 cm , 20 cm , 3mm,18 cm , 20 cm ,
4mm,18 cm , 20 cm , 5mm,18 cm , 20 cm ,
6mm,

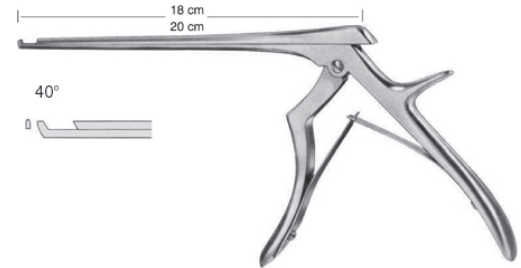
FERRIS-SMITH-KERRISON
JU-9-137-61
FERRIS-SMITH-KERRISON

18 cm , 20 cm , 1mm,18 cm , 20 cm ,
2mm,18 cm , 20 cm , 3mm,18 cm , 20 cm ,
4mm,18 cm , 20 cm , 5mm,18 cm , 20 cm ,
6mm,

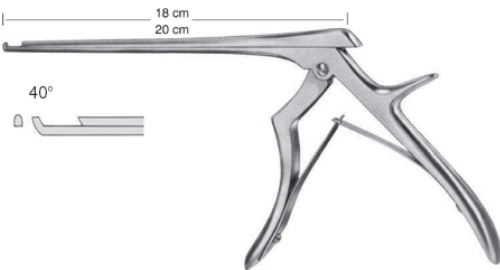
FERRIS-SMITH-KERRISON
JU-9-137-62
FERRIS-SMITH-KERRISON

18 cm , 20 cm , 1mm,18 cm , 20 cm ,
2mm,18 cm , 20 cm , 3mm,18 cm , 20 cm ,
4mm,18 cm , 20 cm , 5mm,18 cm , 20 cm ,
6mm,

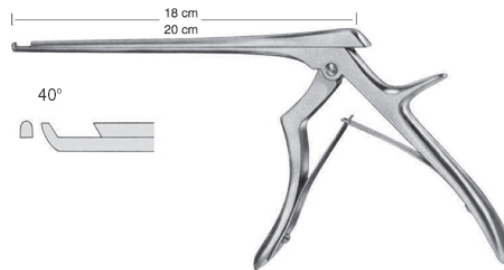
FERRIS-SMITH-KERRISON
JU-9-137-63
FERRIS-SMITH-KERRISON

18 cm , 20 cm , 1mm,18 cm , 20 cm ,
2mm,18 cm , 20 cm , 3mm,18 cm , 20 cm ,
4mm,18 cm , 20 cm , 5mm,18 cm , 20 cm ,
6mm,

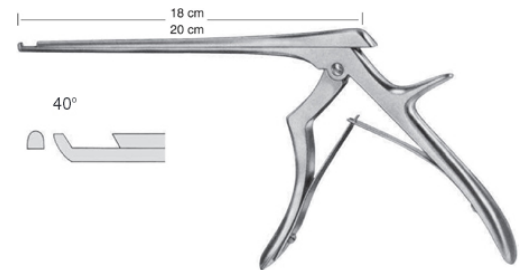
FERRIS-SMITH-KERRISON
JU-9-137-64
FERRIS-SMITH-KERRISON

18 cm , 20 cm , 1mm,18 cm , 20 cm ,
2mm,18 cm , 20 cm , 3mm,18 cm , 20 cm ,
4mm,18 cm , 20 cm , 5mm,18 cm , 20 cm ,
6mm,

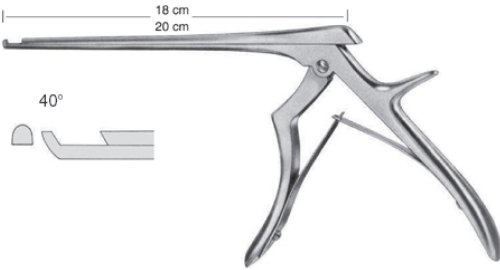
FERRIS-SMITH-KERRISON
JU-9-137-65
FERRIS-SMITH-KERRISON

18 cm , 20 cm , 1mm,18 cm , 20 cm ,
2mm,18 cm , 20 cm , 3mm,18 cm , 20 cm ,
4mm,18 cm , 20 cm , 5mm,18 cm , 20 cm ,
6mm,

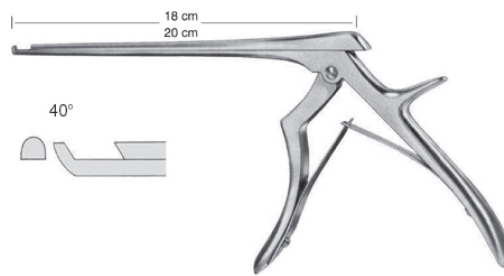
FERRIS-SMITH-KERRISON
JU-9-137-66
FERRIS-SMITH-KERRISON

18 cm , 20 cm , 1mm,18 cm , 20 cm ,
2mm,18 cm , 20 cm , 3mm,18 cm , 20 cm ,
4mm,18 cm , 20 cm , 5mm,18 cm , 20 cm ,
6mm,

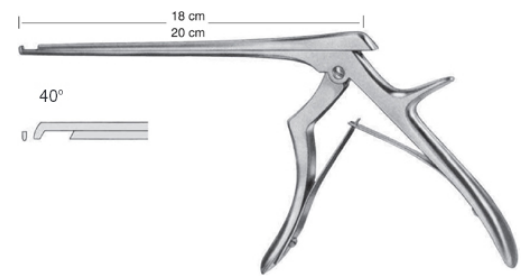
FERRIS-SMITH-KERRISON
JU-9-137-67
FERRIS-SMITH-KERRISON

18 cm , 20 cm , 1mm,18 cm , 20 cm ,
2mm,18 cm , 20 cm , 3mm,18 cm , 20 cm ,
4mm,18 cm , 20 cm , 5mm,18 cm , 20 cm ,
6mm,

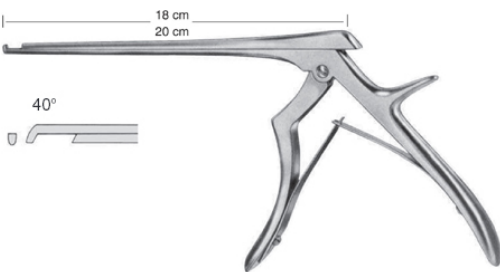
FERRIS-SMITH-KERRISON
JU-9-137-68
FERRIS-SMITH-KERRISON

18 cm , 20 cm , 1mm,18 cm , 20 cm ,
2mm,18 cm , 20 cm , 3mm,18 cm , 20 cm ,
4mm,18 cm , 20 cm , 5mm,18 cm , 20 cm ,
6mm,

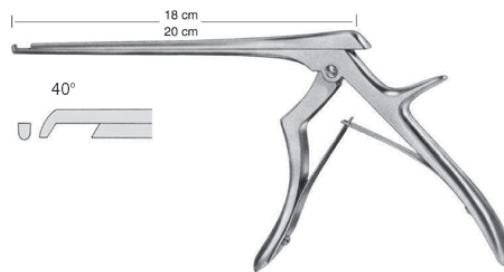
FERRIS-SMITH-KERRISON
JU-9-137-69
FERRIS-SMITH-KERRISON

18 cm , 20 cm , 1mm,18 cm , 20 cm ,
2mm,18 cm , 20 cm , 3mm,18 cm , 20 cm ,
4mm,18 cm , 20 cm , 5mm,18 cm , 20 cm ,
6mm,

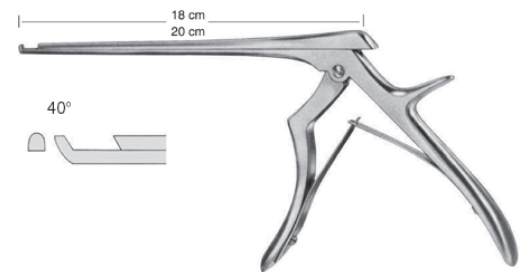
FERRIS-SMITH-KERRISON
JU-9-137-70
FERRIS-SMITH-KERRISON

18 cm , 20 cm , 1mm,18 cm , 20 cm ,
2mm,18 cm , 20 cm , 3mm,18 cm , 20 cm ,
4mm,18 cm , 20 cm , 5mm,18 cm , 20 cm ,
6mm,

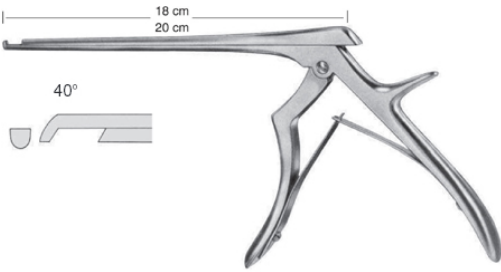
FERRIS-SMITH-KERRISON
JU-9-137-71
FERRIS-SMITH-KERRISON

18 cm , 20 cm , 1mm, 18 cm , 20 cm ,
2mm, 18 cm , 20 cm , 3mm, 18 cm , 20 cm ,
4mm, 18 cm , 20 cm , 5mm, 18 cm , 20 cm ,
6mm,

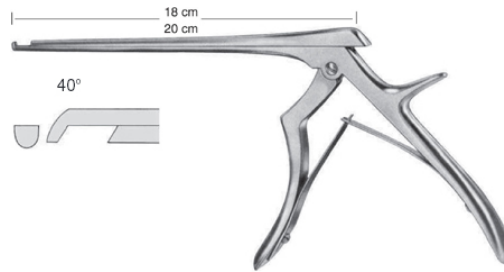

FERRIS-SMITH-KERRISON
JU-9-137-72
FERRIS-SMITH-KERRISON

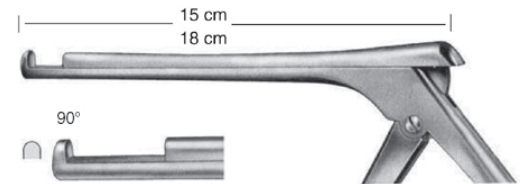
18 cm , 20 cm , 1mm, 18 cm , 20 cm ,
2mm, 18 cm , 20 cm , 3mm, 18 cm , 20 cm ,
4mm, 18 cm , 20 cm , 5mm, 18 cm , 20 cm ,
6mm,

COLCLOUGH
JU-9-137-73
COLCLOUGH

3 mm
5 mm

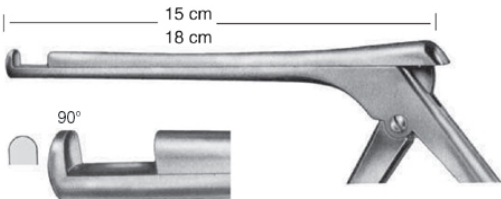
15 cm, 18 cm,

COLCLOUGH
JU-9-137-74
COLCLOUGH

3 mm
5 mm

15 cm, 18 cm,

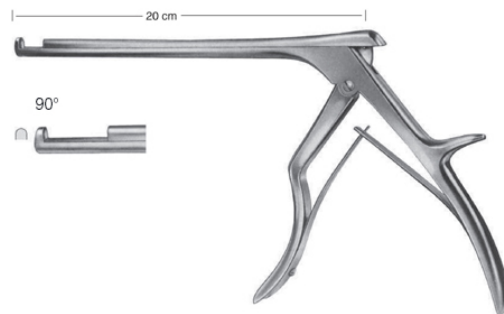
COLCLOUGH
JU-9-137-75
COLCLOUGH

3 mm
5 mm

20 cm,

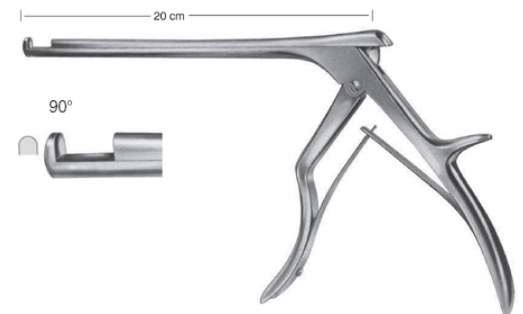

COLCLOUGH
JU-9-137-76
COLCLOUGH

3 mm
5 mm

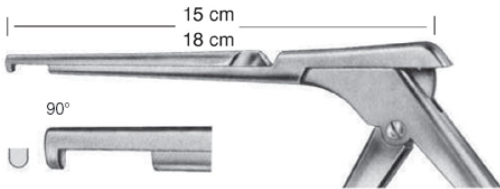
20 cm,

Neurosurgery

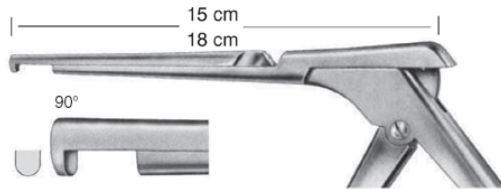
COLCLOUGH
JU-9-137-77
 COLCLOUGH
 3 mm
 5 mm
 15 cm, 18 cm,



COLCLOUGH
JU-9-137-78
 COLCLOUGH
 3 mm
 5 mm
 15 cm, 18 cm,

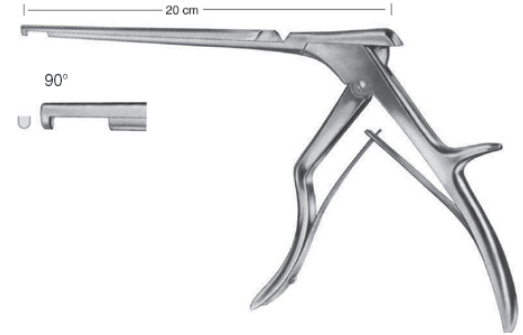

COLCLOUGH
JU-9-137-79
 COLCLOUGH
 3 mm
 5 mm
 20 cm,

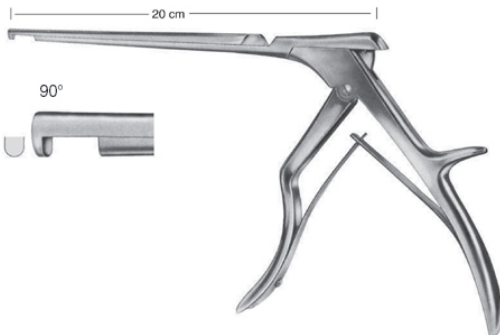

COLCLOUGH
JU-9-137-80
 COLCLOUGH
 3 mm
 5 mm
 20 cm,

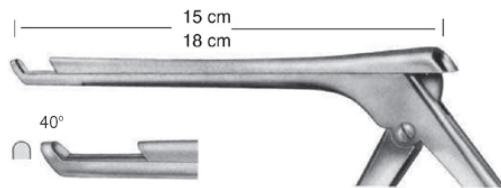

COLCLOUGH
JU-9-137-81
 COLCLOUGH
 3 mm
 5 mm
 15 cm, 18 cm,

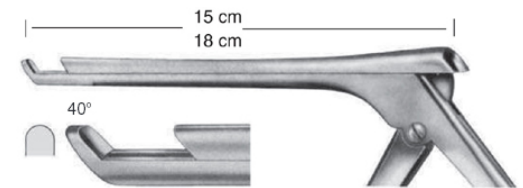

COLCLOUGH
JU-9-137-82
 COLCLOUGH
 3 mm
 5 mm
 15 cm, 18 cm,

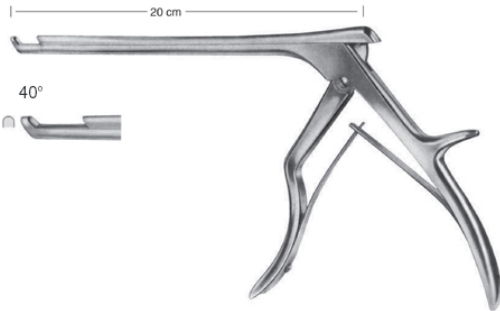
Neurosurgery

COLCLOUGH
JU-9-137-83
 COLCLOUGH
 3 mm
 5 mm
 20 cm,

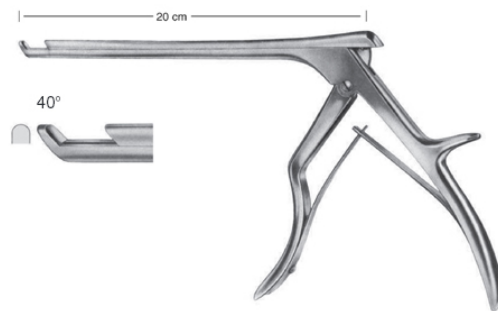

COLCLOUGH
JU-9-137-84
 COLCLOUGH
 3 mm
 5 mm
 20 cm,

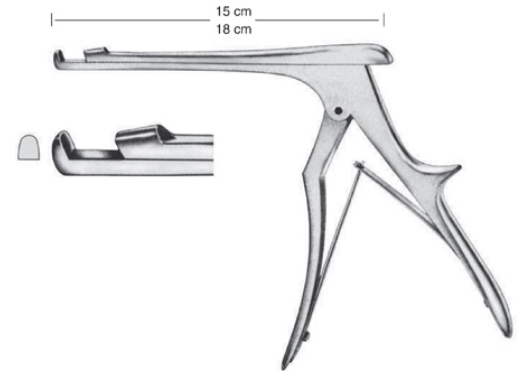

RANEY
JU-9-137-85
 RANEY
 15 cm / 6mm, 18 cm / 6mm,

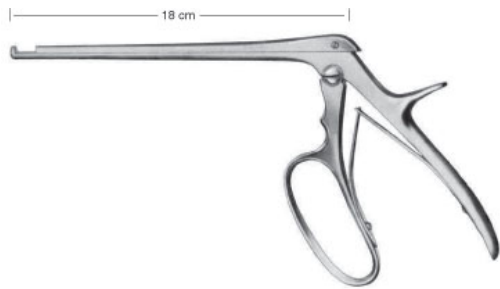

FERRIS-SMITH-KERRISON
JU-9-137-86
 FERRIS-SMITH-KERRISON
 18 cm,

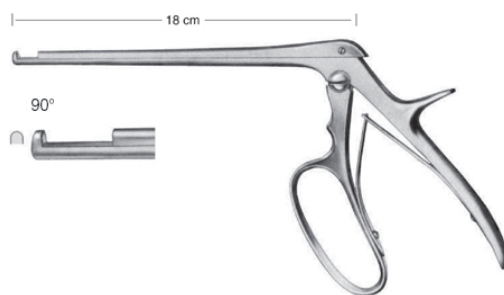

FERRIS-SMITH-KERRISON
JU-9-137-87
 FERRIS-SMITH-KERRISON
 3x3 mm,

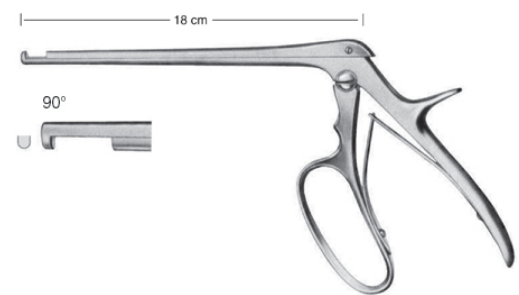

FERRIS-SMITH-KERRISON
JU-9-137-88
 FERRIS-SMITH-KERRISON
 3x3 mm,

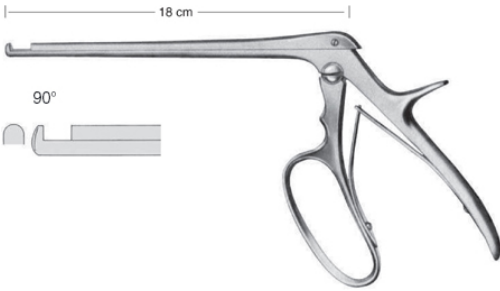
Neurosurgery

FERRIS-SMITH-KERRISON
JU-9-137-89
 FERRIS-SMITH-KERRISON
 5x5 mm,

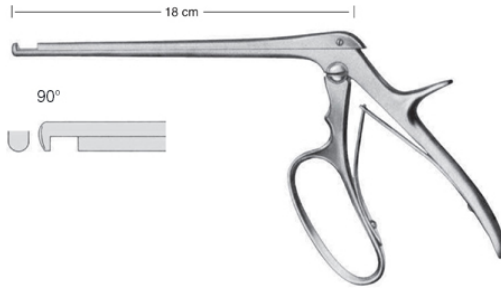

FERRIS-SMITH-KERRISON
JU-9-137-90
 FERRIS-SMITH-KERRISON
 5x5 mm,

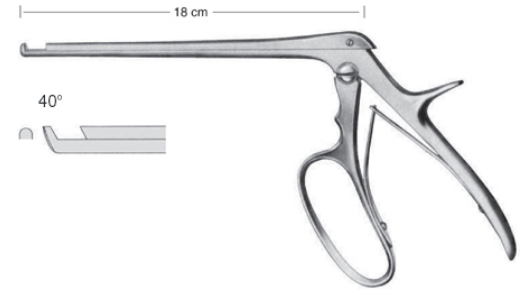

FERRIS-SMITH-KERRISON
JU-9-137-91
 FERRIS-SMITH-KERRISON
 3 mm,

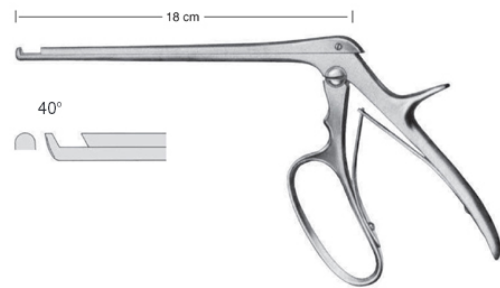

FERRIS-SMITH-KERRISON
JU-9-137-92
 FERRIS-SMITH-KERRISON
 5 mm,

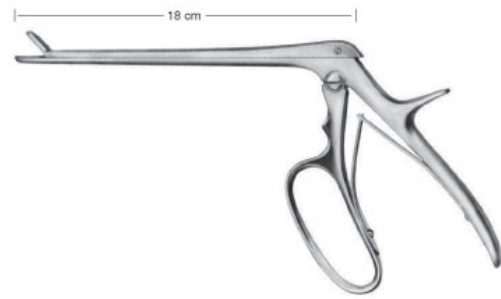

FERRIS-SMITH-CUSHING
JU-9-137-93
 FERRIS-SMITH-CUSHING
 18 cm,

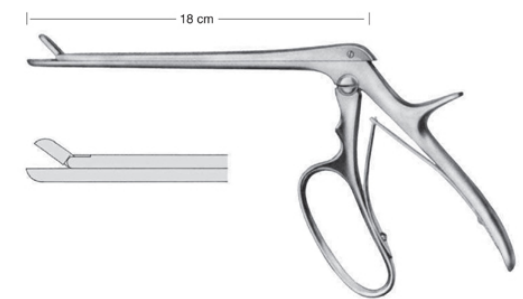

FERRIS-SMITH-CUSHING
JU-9-137-94
 FERRIS-SMITH-CUSHING
 2 x 10 mm, 3 x 10 mm, 4 x 10 mm, 5 x 10
 mm, 6 x 10 mm,

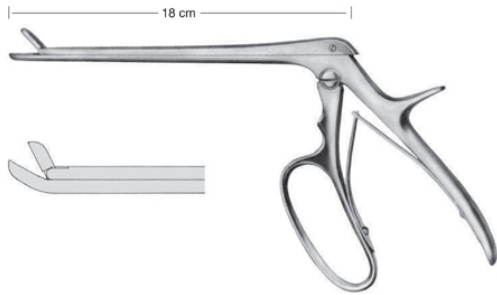
Neurosurgery

FERRIS-SMITH-CUSHING
JU-9-137-95
FERRIS-SMITH-CUSHING

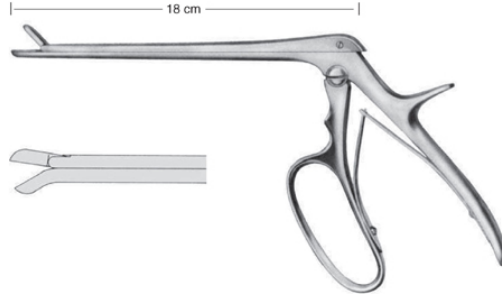
2 x 10 mm, 3 x 10 mm, 4 x 10 mm, 5 x 10 mm, 6 x 10 mm,

FERRIS-SMITH-CUSHING
JU-9-137-96
FERRIS-SMITH-CUSHING

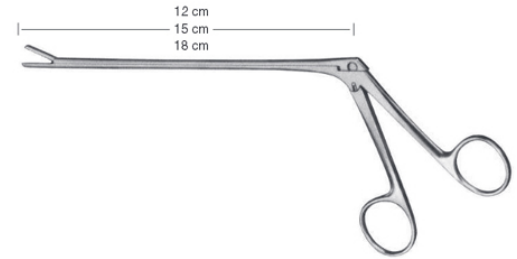
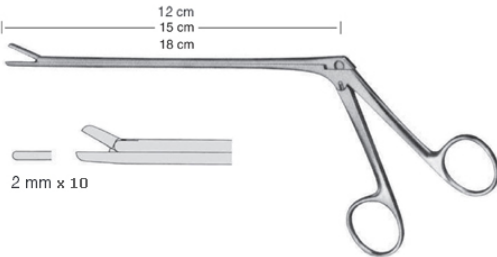
2 x 10 mm, 3 x 10 mm, 4 x 10 mm, 5 x 10 mm, 6 x 10 mm,

CUSHING
JU-9-137-97
CUSHING
CUSHING

CUSHING
JU-9-137-98
CUSHING

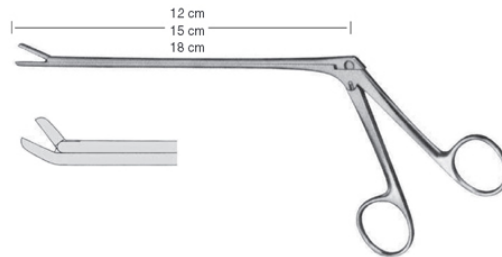
2 mm x 10, 12 cm, 15 cm, 18 cm,

CUSHING
JU-9-137-99
CUSHING

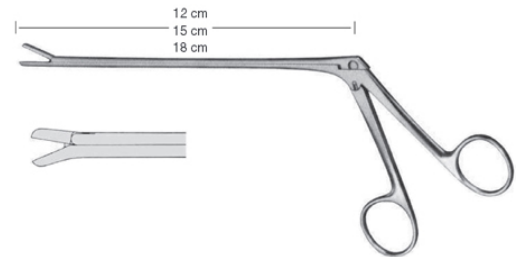
2 mm x 10, 12 cm, 15 cm, 18 cm,

CUSHING
JU-9-137-100
CUSHING

2 mm x 10, 12 cm, 15 cm, 18 cm,

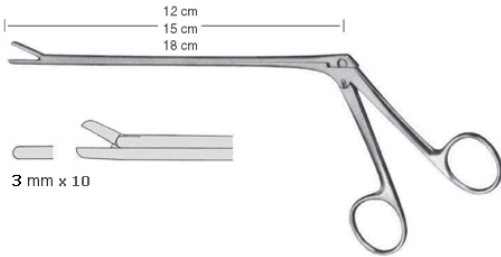

LOVE-GRUENWALD
JU-9-137-101
 LOVE-GRUENWALD
 3 mm x 10, 12 cm, 15 cm, 18 cm,

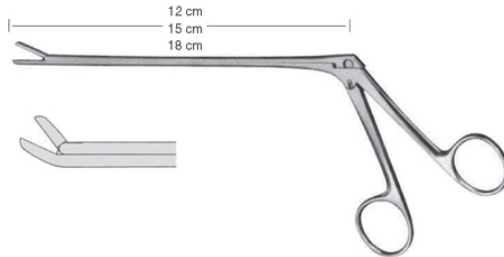

LOVE-GRUENWALD
JU-9-137-102
 LOVE-GRUENWALD
 3 mm x 10, 12 cm, 15 cm, 18 cm,

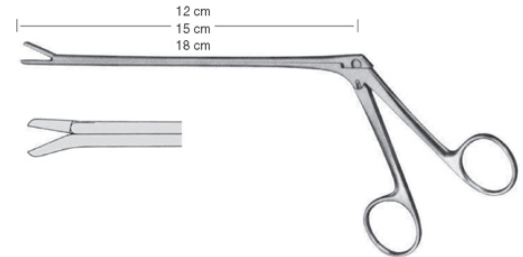

LOVE-GRUENWALD
JU-9-137-103
 LOVE-GRUENWALD
 3 mm x 10, 12 cm, 15 cm, 18 cm,

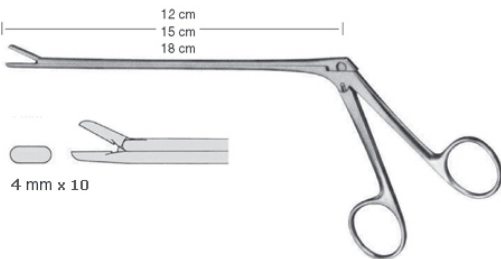

SPURLING
JU-9-137-104
 SPURLING
 4 mm x 10, 12 cm, 15 cm, 18 cm,

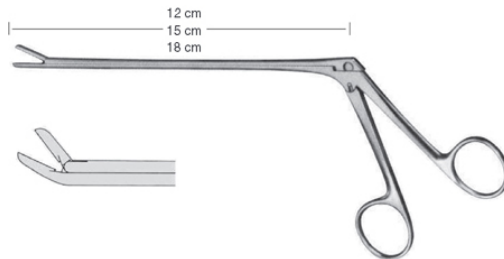

SPURLING
JU-9-137-105
 SPURLING
 4 mm x 10, 12 cm, 15 cm, 18 cm,

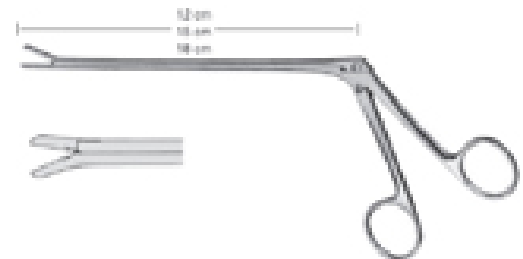

SPURLING
JU-9-137-106
 SPURLING
 4 mm x 10, 12 cm, 15 cm, 18 cm,



OLDBERG
JU-9-137-107
 OLDBERG
 18 cm,



SCHLESINGER
JU-9-137-108
 SCHLESINGER
 15 cm, 2 x 10 mm, 3 x 10 mm, 4 x 10 mm, 5 x 10 mm,



CASPAR
JU-9-137-109
 CASPAR
 2 mm, 14 cm, 15 cm, 16 cm, 18.5 cm,



CASPAR
JU-9-137-110
 CASPAR
 3 mm, 14 cm, 15 cm, 16 cm, 18.5 cm,



CASPAR
JU-9-137-111
 CASPAR
 4 mm, 14 cm, 15 cm, 16 cm, 18.5 cm,



CASPAR
JU-9-137-112
 CASPAR
 5 mm, 14 cm, 15 cm, 16 cm, 18.5 cm,

Neurosurgery

CASPAR
JU-9-137-113

CASPAR
2 mm, 14 cm, 15 cm, 16 cm, 18.5 cm,

CASPAR
JU-9-137-114

CASPAR
3 mm, 14 cm, 15 cm, 16 cm, 18.5 cm,

CASPAR
JU-9-137-115

CASPAR
4 mm, 14 cm, 15 cm, 16 cm, 18.5 cm,



CASPAR
JU-9-137-116

CASPAR
2 mm, 14 cm, 15 cm, 16 cm, 18.5 cm,

CASPAR
JU-9-137-117

CASPAR
3 mm, 14 cm, 15 cm, 16 cm, 18.5 cm,

CASPAR
JU-9-137-118

CASPAR
4 mm, 14 cm, 15 cm, 16 cm, 18.5 cm,

Neurosurgery



YASARGIL
JU-9-137-119

YASARGIL
25 cm, 2.2 cm, 3.5 cm, 4.0 cm,

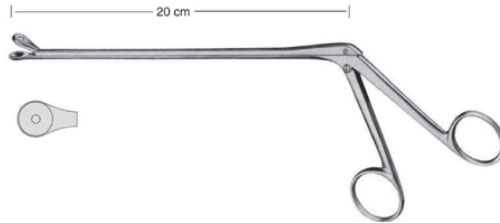

LANDOLT
JU-9-137-120

LANDOLT
27 cm, 9 mm,



OLIVECRONA-TOENNIS
JU-9-137-121

14 cm,

Cardiovascular

JU-9-101-23
Bone Shear
23 cm,



JU-9-102-22
Rib Shear
23 cm,



Gluck
JU-9-103-22
Rib Shears
21 cm,



Giertz-Stille
JU-9-104-27
Rib Shear
24.5 cm,



Lebsche
JU-9-105-24
Sternum Chisel
24.5 cm,



JU-9-106-01
Rib Retractor lateral blades 12 x 16 mm
spreading 95 mm
Size 1,

Cardiovascular

Finochietto, Infant
JU-9-107-01

Rib Retractor lateral blades 15 x 15 mm
spreading 75 mm
Size 1,



Finochietto, Baby
JU-9-108-01

Rib Retractor lateral blades 31 x 31 mm
spreading 100 mm
Size 1,



Finochietto
JU-9-109-01

Rib Retractor lateral blades 40 x 45 mm
spreading 135 mm
Size 1,



Burford
JU-9-110-01

Rib Retractor with two pairs of blades 47 x 62 mm + 65 x 62 mm, spreading 200 mm
Size 1,



Castaneda
JU-9-111-01

Rib Retractor lateral blades 10,5 x 32 mm
spreading 65 mm
Size 1,



Finochietto (modif.)
JU-9-112-01

Rib Retractor lateral blades 14 x 15 mm
spreading 120 mm
Size 1,

Cardiovascular

Haight
JU-9-113-90

Rib Retractor lateral blades 30 x 30 mm
spreading 120 mm
Size 1,

Morse-Favaloro
JU-9-114-01

Sternal Retractor 4 movable blades 17 x 22
mm spreading 160 mm Sternal Retractor
Size 1,

Morse
JU-9-115-00

Sternal Retractor 4 movable blades 22 x 27
mm spreading 200 mm
Size 1,

Tuffier
JU-9-116-02

Rib Retractor lateral blades 22 x 27 mm
spreading 200 mm
Size 1,

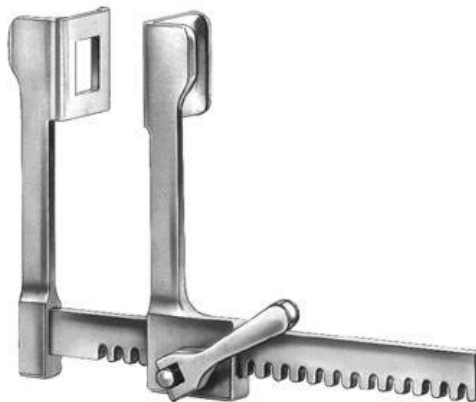
Finochietto, Baby
JU-9-117-75

Rib Retractor lateral blades 14 x 15 mm
spreading 75 mm
Size 1,

Finochietto
JU-9-118-01

Rib Retractor lateral blades 30 x 45 mm
spreading 150 mm
Size 1,

Cardiovascular

DeBakey
JU-9-119-00

 Rib Retractor spreading 150 mm
Size 1,

DeBakey
JU-9-120-00

 Rib Retractor spreading 200 mm
Size 1,

JU-9-121-00

 Thoracic Retractor
Size 1,

Sallors
JU-9-122-19

 Rib Contractor
20 cm,

Bailey-Baby
JU-9-123-14

 Rib Contractor
15.5 cm,

Bailey
JU-9-124-16

 Rib Contractor
20 cm,

Cardiovascular



Bailey-Gibbon
JU-9-125-16
 Rib Contractor
 20 cm,



Allison
JU-9-126-30
 Lung Spatula
 29.5 cm, 32.5 cm,

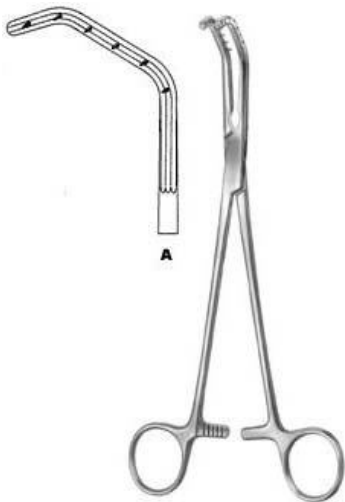

Price-Thomas
JU-9-127-22
 Bronchus Clamp
 22 cm,



Price-Thomas
JU-9-128-22
 Bronchus Clamp
 22 cm,

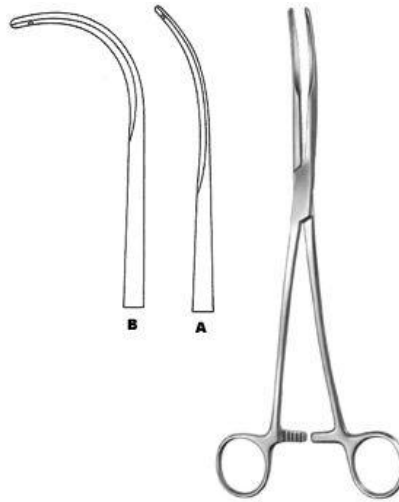

Semb
JU-9-129-24
 Bronchus Clamp
 24.5 cm,

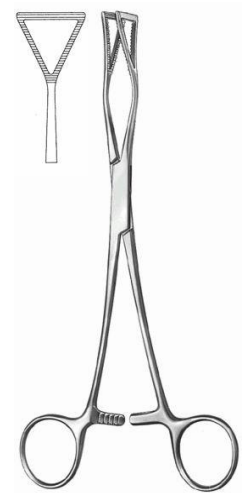

Lovelace
JU-9-130-20
 Lung Grasping Forceps
 20.5 cm,

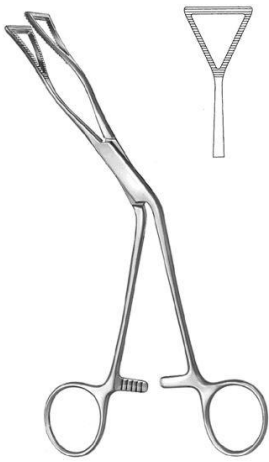
Cardiovascular

Lovelace
JU-9-131-20
 Lung Grasping Forceps
 19 cm,



DeBakey-Satinsky
JU-9-132-07
 Bulldog Clamp
 7 cm, 9 cm,



Glover
JU-9-133-06
 Bulldog Clamp
 6 cm,



Santulli
JU-9-134-07
 Bulldog Clamp
 7 cm,



Gregory, soft
JU-9-135-09
 Bulldog Clamp
 9 cm, 11 cm,

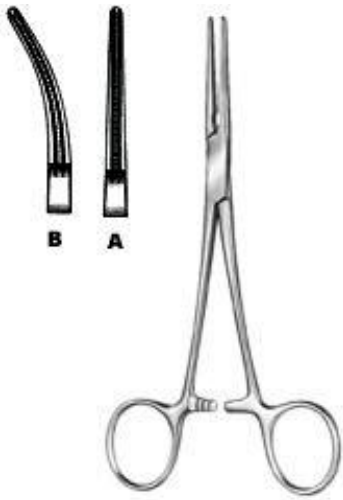

Gregory
JU-9-136-01
 Bulldog Clamp
 10.5 cm,

Cardiovascular

DeBakey-Rankin
JU-9-137-16
 Haemostatic Forceps
 16 cm,



DeBakey-Mosquito
JU-9-138-15
 Haemostatic Forceps
 15 cm,



Ochsner
JU-9-139-23
 Aortic Clamp
 23.5 cm,



Diethrich
JU-9-140-21
 Aortic Clamp
 22 cm,

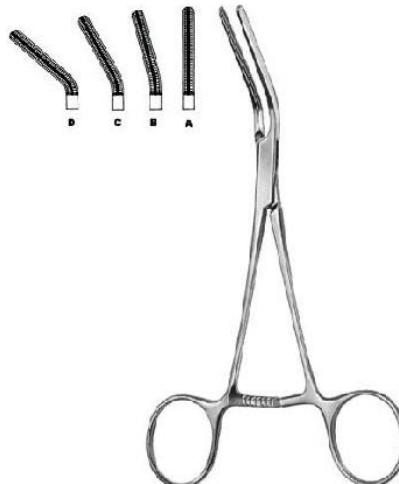

Dardik
JU-9-141-00
 Multi purpose Vascular Clamp
 15 cm,

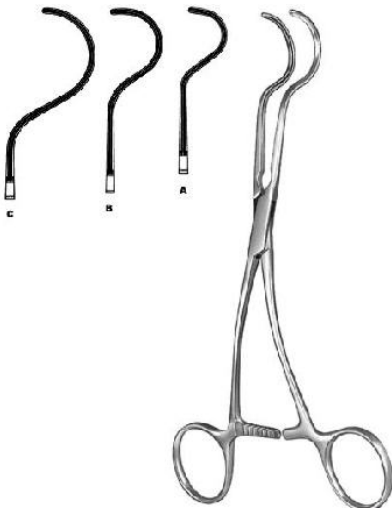

Dale
JU-9-142-18
 Peripheral Vascular Clamp
 18 cm,

Cardiovascular

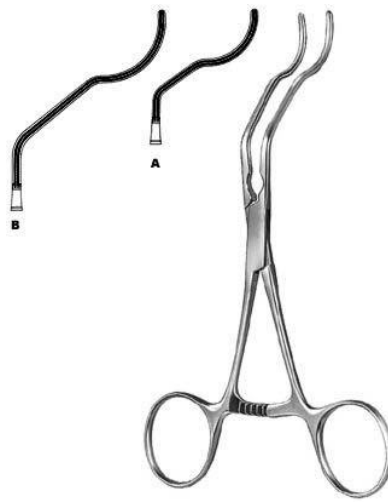
Dale
JU-9-143-17

 Peripheral Vascular Clamp
17.5 cm,

Gregory
JU-9-144-14

 Profunda Clamp
13 cm, 16 cm, 18 cm,

Martin
JU-9-145-16

 Peripheral Vascular Clamp
16.5 cm,

Husfeldt
JU-9-146-18

 Peripheral Vascular Clamp
17.5 cm,

Husfeldt
JU-9-147-18

 Peripheral Vascular Clamp
18 cm,

Husfeldt
JU-9-148-17

 Peripheral Vascular Clamp
17 cm,

Cardiovascular



DeBakey
JU-9-149-16
 Vascular Forceps
 16 cm,



DeBakey
JU-9-150-16
 Vascular Forceps
 16 cm,

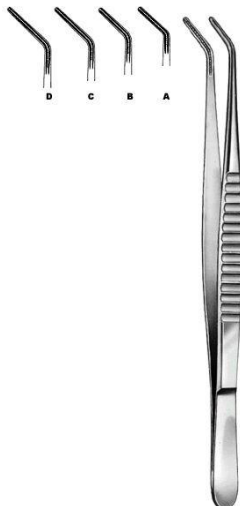

DeBakey
JU-9-151-16
 Vascular Forceps
 16 cm,



DeBakey
JU-9-152-16
 Vascular Forceps
 16 cm,



DeBakey
JU-9-153-16
 Vascular Forceps
 16 cm,



DeBakey
JU-9-154-07
 Bulldog Clamp
 7.5 cm,

Cardiovascular

DeBakey
JU-9-155-07
 Bulldog Clamp
 7.5 cm,



JU-9-156-23
 Applying Forceps
 23.5 cm,

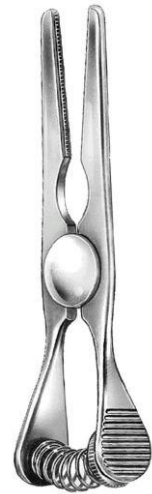

Glover
JU-9-157-06
 Bulldog Clamp
 7 cm,



Glover
JU-9-158-06
 Bulldog Clamp
 6.5 cm,

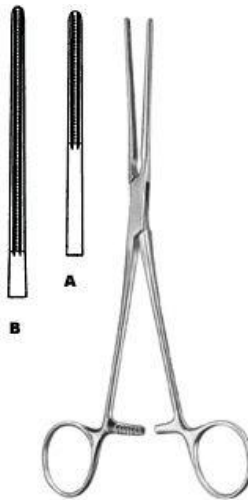

Potts
JU-9-159-21
 Coarctation Clamp
 21 cm,

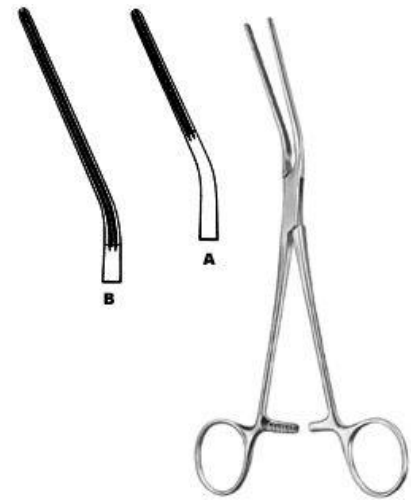

Potts
JU-9-160-21
 Coarctation Clamp
 20.5 cm,

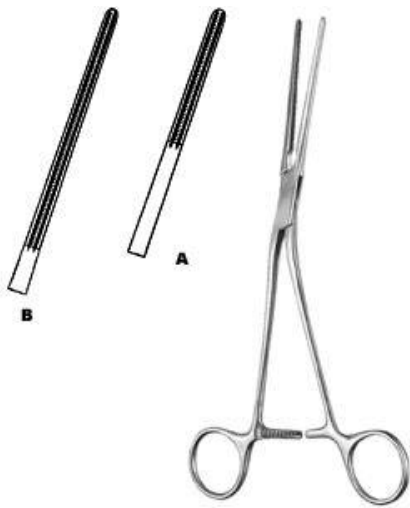
Cardiovascular

Potts
JU-9-161-21
 Coarctation Clamp
 20.5 cm,



Potts
JU-9-162-22
 Anastomosis Clamp
 21.5 cm,



Potts
JU-9-163-22
 Anastomosis Clamp
 22 cm,

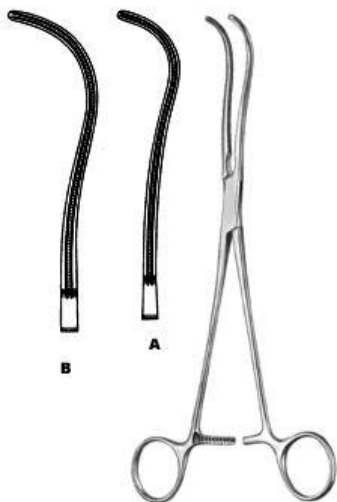

DeBakey
JU-9-164-19
 Ligature Forceps
 19 cm,



DeBakey
JU-9-165-16
 Peripheral Vascular Clamp
 16 cm,

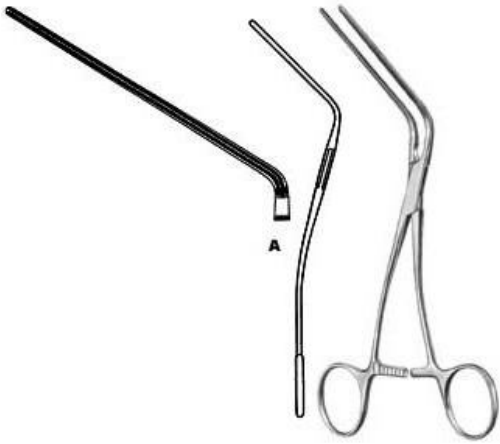

DeBakey
JU-9-166-19
 Peripheral Vascular Clamp
 16 cm,

Cardiovascular

Leland-Jones
JU-9-167-18
 Peripheral Vascular Clamp
 18 cm,



Bainbridge
JU-9-168-15
 Multi purpose Vascular Clamp
 15 cm,



Bainbridge
JU-9-169-15
 Multi purpose Vascular Clamp
 15 cm,

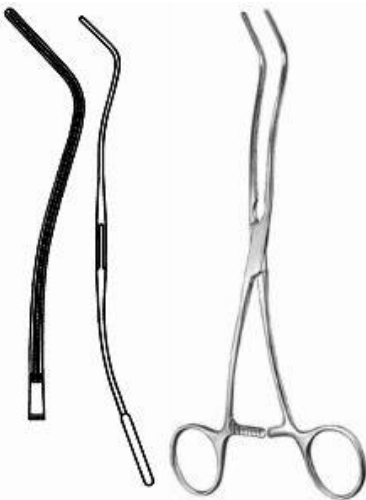

DeBakey
JU-9-170-20
 Multi purpose Vascular Clamp
 20 cm,



DeBakey
JU-9-171-26
 Aortic Aneurysm Clamp
 26 cm,

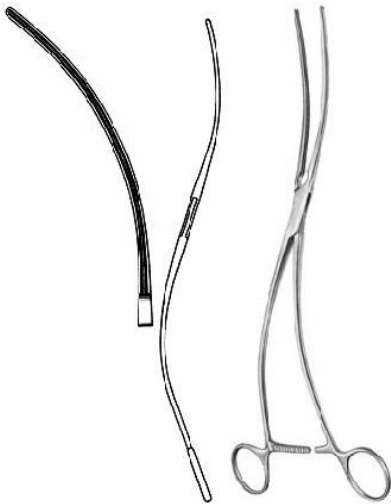

DeBakey
JU-9-172-28
 Aortic Aneurysm Clamp
 28 cm,

Cardiovascular

DeBakey
JU-9-173-30
 Aortic Aneurysm Clamp
 30 cm,



DeBakey
JU-9-174-27
 Aortic Clamp
 27 cm,



DeBakey
JU-9-175-24
 Ligature Forceps
 24.5 cm,



DeBakey
JU-9-176-24
 Ligature Forceps
 24.5 cm,



DeBakey
JU-9-178-25
 Ligature Forceps
 27 cm,

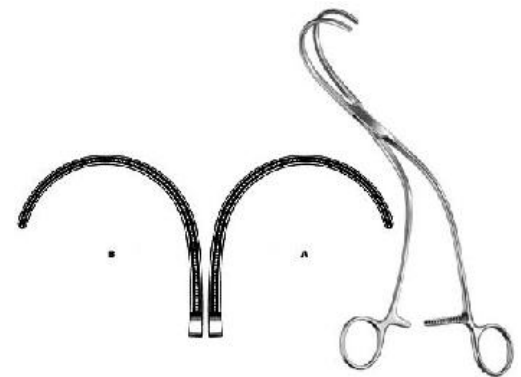

Weber
JU-9-179-01
 Aortic Clamp
 24 cm,

Cardiovascular

Satinsky
JU-9-180-20
 Tangential Occlusion Clamp
 22 cm,



Harken
JU-9-181-01
 Auricle Clamp
 24.5 cm,



Lees
JU-9-182-23
 Bronchus Clamp
 23 cm,



Lees
JU-9-183-25
 Bronchus Clamp
 25 cm,



Lambert-Kay
JU-9-184-21
 Anastomosis Clamp
 22.5 cm,



DeBakey
JU-9-185-17
 Anastomosis Clamp
 16.5 cm,

Cardiovascular



Morris-DeBakey
JU-9-186-18
 Aortic Clamp
 16.5 cm,

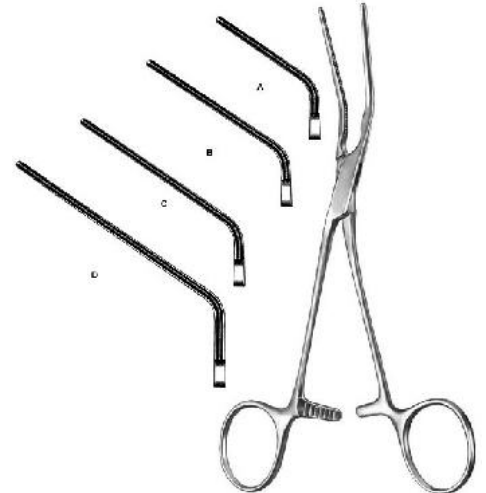

DeBakey-Bahnson
JU-9-187-23
 Aneurysm Clamp
 23.5 cm,

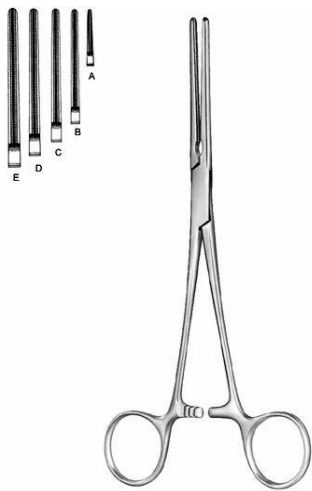

DeBakey
JU-9-188-20
 Multi purpose Vascular Clamp
 18 cm,



DeBakey-Mosquito
JU-9-189-12
 Haemostatic Forceps
 12.5 cm,

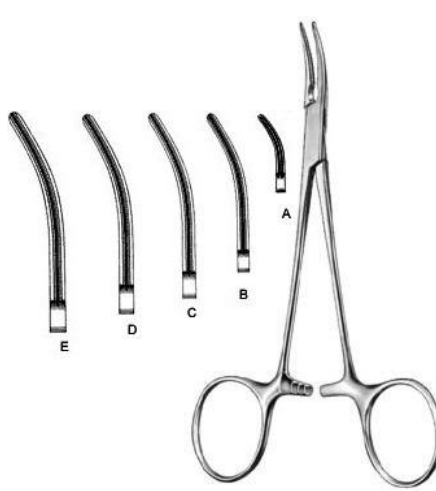

DeBakey-Mosquito
JU-9-190-12
 Haemostatic Forceps
 12.5 cm,



DeBakey
JU-9-191-17
 Multi purpose Vascular Clamp
 17 cm,

Cardiovascular

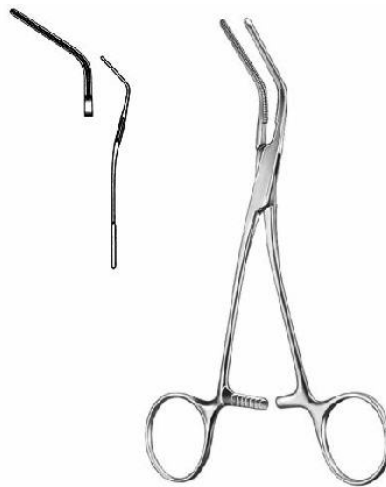

DeBakey
JU-9-192-16

Multi purpose Vascular Clamp
16.5 cm,

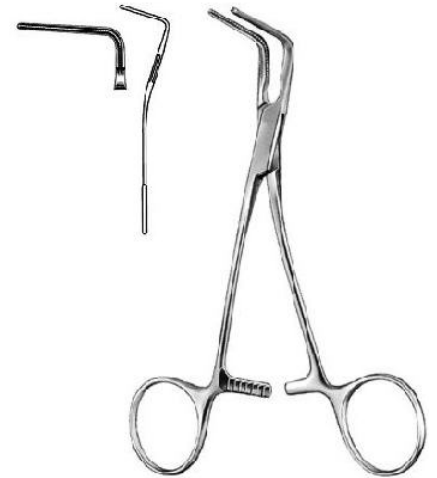

DeBakey
JU-9-193-15

Multi purpose Vascular Clamp
16 cm,



DeBakey
JU-9-194-15

Multi purpose Vascular Clamp
16.5 cm,



DeBakey
JU-9-195-17

Multi purpose Vascular Clamp
16.5 cm,



Glover
JU-9-196-17

Multi purpose Vascular Clamp
17 cm,



Glover
JU-9-197-17

Multi purpose Vascular Clamp
17.5 cm,

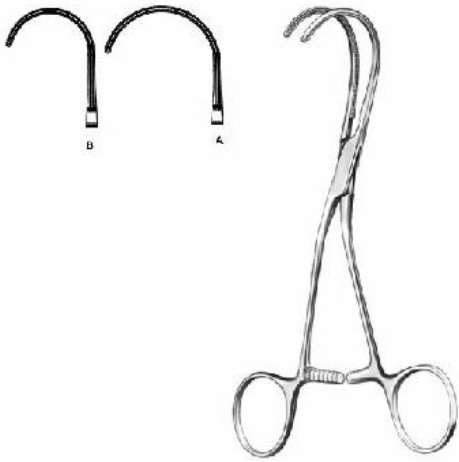
Cardiovascular

DeBakey
JU-9-198-16
 Multi purpose Vascular Clamp
 16.5 cm,

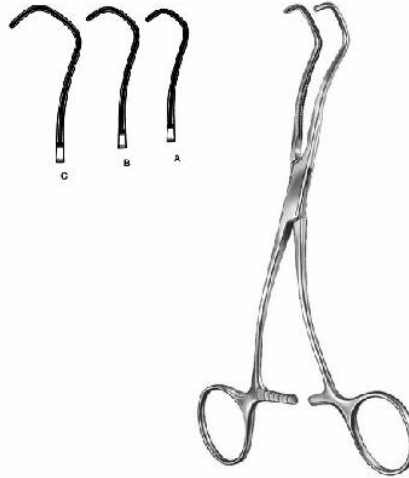

Derra
JU-9-199-16
 Anastomosis Clamp
 16.5 cm Fig. 1, 17 cm Fig. 2, 18 cm Fig. 3,



DeBakey-Beck
JU-9-200-17
 Anastomosis Clamp
 17 cm,



Cooley
JU-9-201-16
 Vascular Forceps
 16 cm,

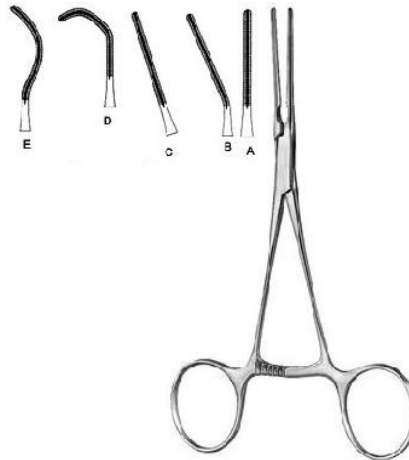

Cooley
JU-9-202-01
 Pediatric Vascular Clamp
 14.5 cm,



Cooley
JU-9-203-21
 Iliac Clamp
 22 cm,

Cardiovascular

Cooley
JU-9-204-17
Anastomosis Clamp
17 cm,

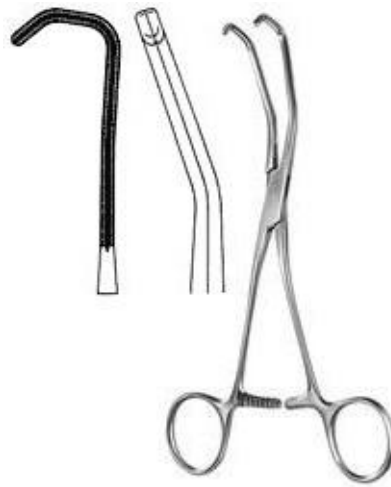

Cooley
JU-9-205-17
Anastomosis Clamp
20 cm,



Cooley
JU-9-206-16
Anastomosis Clamp
17 cm,



Cooley
JU-9-207-15
Multi purpose Vascular Clamp
16 cm,



Cooley
JU-9-208-17
Multi purpose Vascular Clamp
17 cm,



Cooley
JU-9-209-17
Multi purpose Vascular Clamp
17 cm,

Cardiovascular

Cooley
JU-9-210-17
Multi purpose Vascular Clamp
17.5 cm,

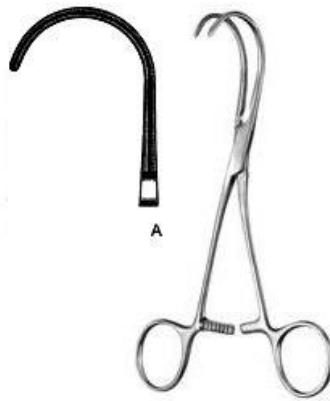

Cooley
JU-9-211-16
Multi purpose Vascular Clamp
16.5 cm,



Cooley-Derra
JU-9-212-16
Anastomosis Clamp
16.5 cm,



Cooley-Beck
JU-9-213-17
Anastomosis Clamp
17 cm,

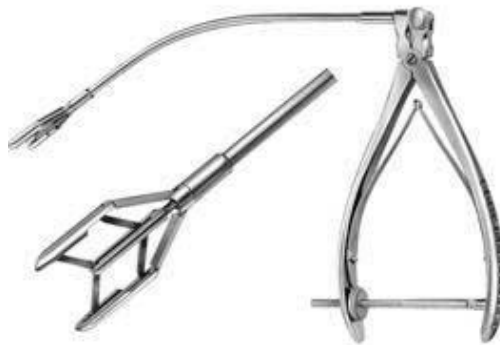

Cooley
JU-9-214-00
Aortic Dilator



Cooley
JU-9-215-05
Vascular Dilator
13 cm 0,5 mm ?,

Cardiovascular

DeBakey
JU-9-216-05
 Vascular Dilator
 19 cm 0,5 mm ?



Martin
JU-9-217-00
 Tunneling Set complete set with three shafts, two handles and 12 tips in storage case.



Hach
JU-9-218-01
 Fasciotomy Knife with plastic handle
 30 cm,



JU-9-219-18
 Intima Spatula
 18.5 cm,

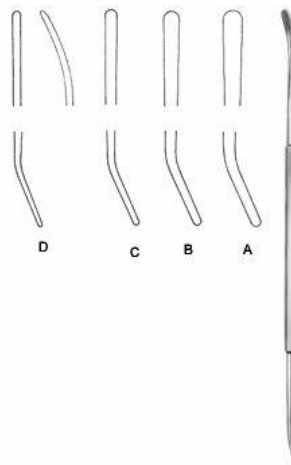

Robb
JU-9-220-01
 Vascular Dissector
 24 cm Fig. 1 2,5 mm ?, 24 cm Fig. 2 2,0 mm ?

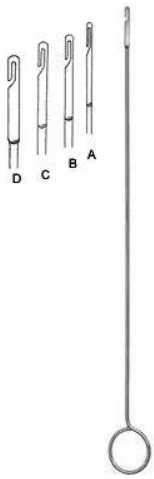

Crile
JU-9-221-20
 Nerve Hooklet
 20 cm,

Cardiovascular

JU-9-222-15
Ligature Catcher
26 cm 1,5 mm,



Subramanian-Miniature
JU-9-223-15
Aortic Clamp 135 degree
15.5 cm,

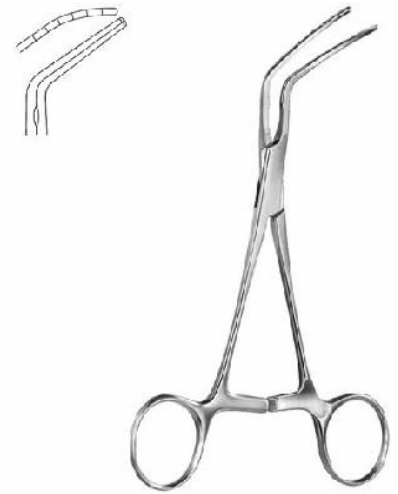

Subramanian
JU-9-224-16
Aortic Clamp
16 cm,

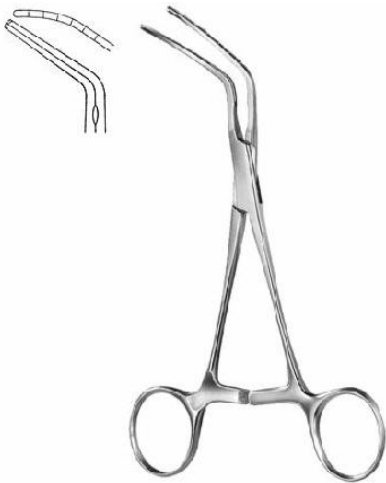

Subramanian
JU-9-225-16
Aortic Clamp

13.5 cm Fig. 1, 13.5 cm Fig. 2, 14 cm Fig. 3,

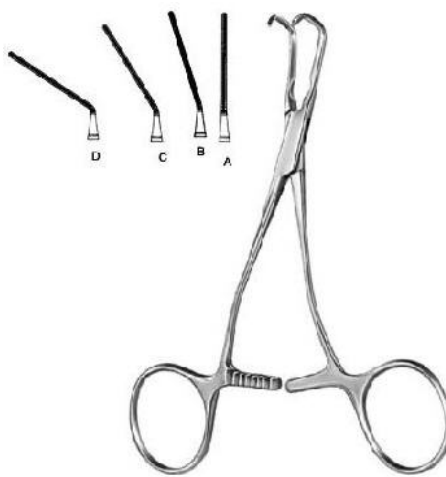

JU-9-226-01
Pediatric Vascular Clamp



JU-9-227-16
Pediatric Vascular Clamp
16.5 cm,



JU-9-228-16
Pediatric Vascular Clamp
16 cm,

Ophthalmology

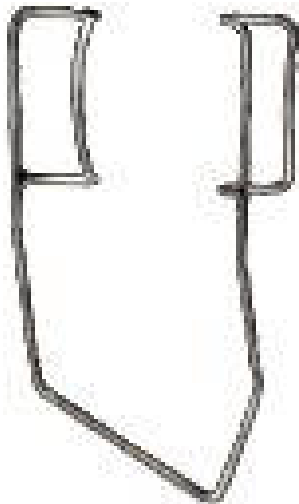

Barraquer (Colibri)
JU-11-101-03
Barraquer
Size 1,

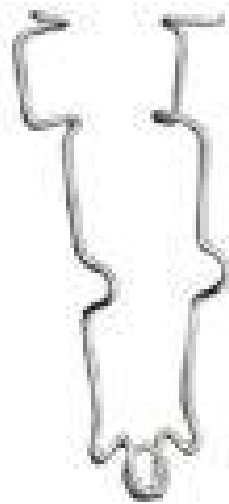

JU-11-102-07
Bowman
Size 1,



JU-11-103-06
Critchett
Size 1,



JU-11-104-05
Smith
Size 1,

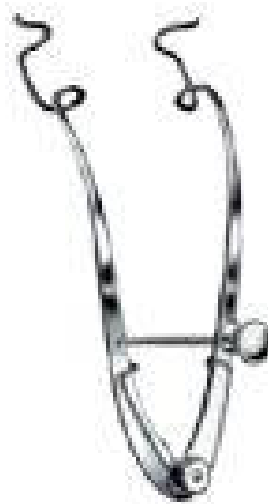

JU-11-105-08
Clark
Size 1,

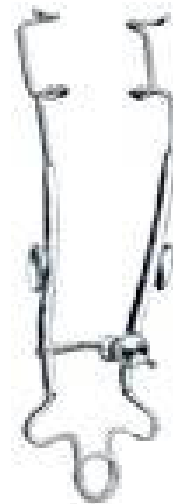

JU-11-106-06
Graefe
Size 1,

Ophthalmology

JU-11-107-08
Week
Size 1,



JU-11-108-07
Arruga
Size 1,



JU-11-109-07
Arruga
Size 1,



JU-11-110-05
Murdock
Size 1,



Millenger
JU-11-111-07
Mellinger Axenfeld
Size 1,



Millenger
JU-11-112-07
Mellinger Axenfeld
Size 1,

Ophthalmology



Millinger
JU-11-113-07
 Mellinger
 Size 1,



JU-11-114-08
 Lister Burch
 Size 1,



Williams Eye Speculum
JU-11-115-08
 Williams
 7 cm, 8.3 cm,



Lancaster
JU-11-116-07
 Lancaster
 Size 1,



JU-11-118-08
 Ziegler
 Size 1,

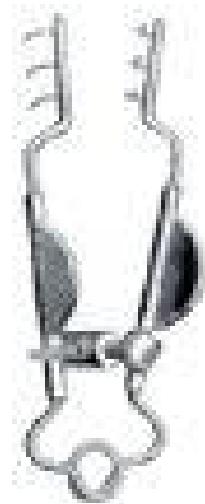

Mueller
JU-11-120-07
 Mueller
 Size 1,

Ophthalmology

Jaeger Lid Plate
JU-11-121-11
 Jaeger
 4", 20mm, 23mm,



VON GRAEFE Knife
JU-11-122-03
 Graefe
 1, 2, 3, 4, 5,



JU-11-123-01
 Jaeger
 Size 1,



JU-11-124-13
 Berens
 Size 1,



ZIEGLER knife Needle
JU-11-126-01
 Ziegler
 11.4 cm,



Castroviejo Cyclodialysis Spatula
JU-11-127-12
 Castroviejo
 13.3 cm,

Ophthalmology

JU-11-128-12
Wheeler
Size 1,



Castroviejo Cyclodialysis Spatula
JU-11-129-05
Castroviejo
Size 1,



JU-11-130-12
Dix
Size 1,



JU-11-131-13
Dix
Size 1,



JU-11-132-13
Dix
Size 1,



Castroviejo Caliper
JU-11-133-07
Castroviejo
8.3 cm,

Ophthalmology



JU-11-134-13
Connin Amsler
Size 1,



JU-11-135-06
Dastoor
Size 1,



JU-11-136-09
Holth
Size 1,



Wilder Lacrimal Dilator
JU-11-137-03
Wilder
10.2 cm,



ZIEGLER Lacrimal Dilator
JU-11-138-12
Ziegler
14 cm Double End,



Castroviejo Lacrimal Dilator
JU-11-139-12
Castroviejo
14 cm,

Ophthalmology



JU-11-140-78
Bowman
Size 1,



JU-11-141-07
Graefe
Size 1,



JU-11-142-07
Graefe
Size 1,



JU-11-143-07
Graefe
Size 1,



JU-11-144-07
Graefe
Size 1,



JU-11-145-07
Fischer
Size 1,

Ophthalmology



JU-11-146-07
Barraquer Katzin
Size 1,



JU-11-147-07
Troutman
Size 1,



JU-11-148-07
Barraquer
Size 1,



JU-11-149-07
Barraquer
Size 1,



JU-11-150-09
McCullough
Size 1,



JU-11-151-09
McCullough
Size 1,

Ophthalmology



JU-11-152-10
Jameson
Size 1,



JU-11-153-10
Jameson
Size 1,



JU-11-154-10
Bonaccolto
Size 1,



JU-11-155-10
Bonaccolto
Size 1,



JU-11-156-10
Dastoor
Size 1,



JU-11-157-10
Dastoor
Size 1,

Ophthalmology



JU-11-158-05
Bishop Harman
Size 1,



JU-11-159-08
Bishop Harman
Size 1,



JU-11-160-05
Bishop Harman
Size 1,



JU-11-161-08
Bishop Harman
Size 1,



JU-11-162-07
Mod Bonn
Size 1,



JU-11-163-07
Mod Bonn
Size 1,

Ophthalmology



JU-11-164-10
Mod Bonn
Size 1,



JU-11-165-10
Mod Bonn
Size 1,



JU-11-166-10
Mod Bonn
Size 1,



JU-11-167-10
Mod Bonn
Size 1,



JU-11-168-10
Prince
Size 1,



JU-11-169-10
Prince
Size 1,

Ophthalmology



JU-11-170-20
Berke
Size 1,



JU-11-171-08
Troutman
Size 1,



JU-11-172-05
Barraquer
Size 1,



JU-11-173-11
Elsching
Size 1,



JU-11-174-11
Graefe
Size 1,



JU-11-175-09
Lester
Size 1,

Ophthalmology

JU-11-176-09
Castroviejo
Size 1,



JU-11-178-09
Castroviejo
Size 1,



JU-11-179-09
Barraquer
Size 1,



JU-11-180-10
Green
Size 1,



JU-11-181-07
Gill Arruga
Size 1,



JU-11-182-01
Castroviejo
Size 1,

Ophthalmology



JU-11-183-05
Castroviejo
Size 1,



JU-11-184-10
Moorfield
Size 1,



JU-11-185-07
St Martin
Size 1,



JU-11-186-10
Mod Tubingen
Size 1,



JU-11-187-10
McPherson
Size 1,



JU-11-188-10
McPherson
Size 1,

Ophthalmology



JU-11-189-09
Ayer
Size 1,



JU-11-190-09
Ayer
Size 1,



JU-11-191-09
Desmarres
Size 1,



JU-11-192-10
Snellen
Size 1,



JU-11-1193-11
Knapp Luer
Size 1,



JU-11-194-28
Scheie
Size 1,

Ophthalmology



JU-11-195-45
Mod Tubingen
Size 1,



JU-11-196-00
Elliot
Size 1,



JU-11-197-09
Beer
Size 1,

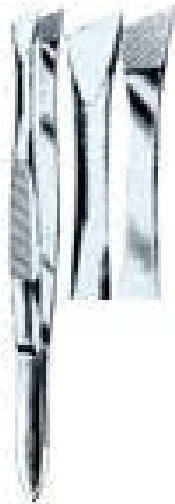

JU-11-198-10
Barraquer

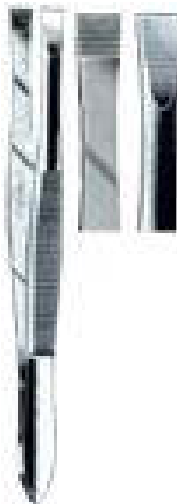

JU-11-199-09
Douglas
Size 1,



JU-11-200-09
Gradle
Size 1,



JU-11-177-09
Castroviejo
Size 1,

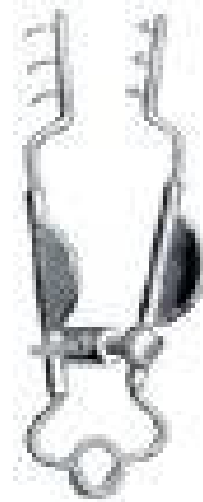

JU-11-119-07
Mueller
Size 1,

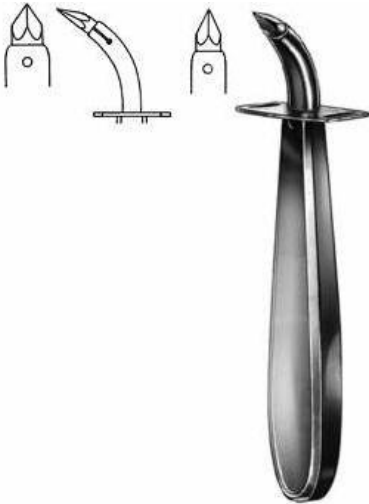
Tracheotomy

Ueckermann
JU-16-101-13
 Tracheotomy Trocar
 11.5 cm,



Iterson
JU-16-102-16
 Tracheal Hook
 17 cm,



Rose
JU-16-103-13
 Tracheal Hook
 13.5 cm,



Luer
JU-16-104-11
 Tracheal Hook
 11 cm,

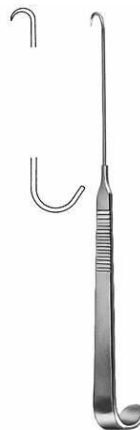

JU-16-105-15
 Tracheal Hook
 15 cm,

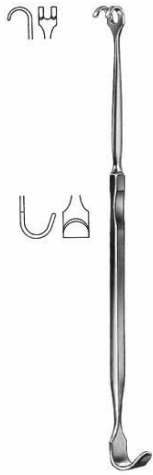

Lukens
JU-16-106-17
 Thymus Retractor
 17.5 cm,

Tracheotomy

Jackson
JU-16-107-17
 Tracheal Hook
 18 cm,



Kocher
JU-16-108-15
 Goitre Enucleator
 16.5 cm,



Kocher
JU-16-109-15
 Goitre Enucleator
 16.5 cm,



Hofmeister
JU-16-110-21
 Goitre Enucleator
 20.5 cm,

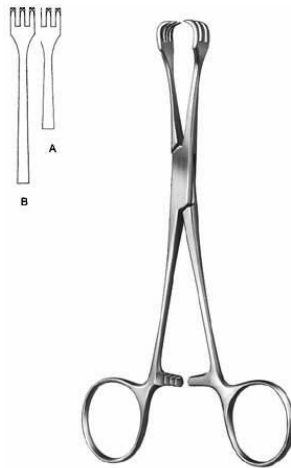

Lahey
JU-16-111-15
 Goitre Grasping Forceps
 15.5 cm,



Luer
JU-16-112-04
 Tracheal Tube

Tracheotomy



Luer
JU-16-113-08
Tracheal Tube



Chevalier-Jackson
JU-16-114-04
Tracheal Tube outer tube closed inner tube
closed silver



JU-16-115-08
Speaking Tube

Dermatology

Moncorps
JU-17-101-14
 Milium Knife
 14 cm,



Moncorps
JU-17-102-00
 Spare Blade



Vidal
JU-17-103-14
 Lupus Scraper
 13 cm,



Wolff
JU-17-105-01
 Lupus Curette
 14 cm,



Kilner
JU-17-106-15
 Skin Hooklet
 14.5 cm,



Gillies
JU-17-107-18
 Skin Hooklet
 18 cm,

Dermatology

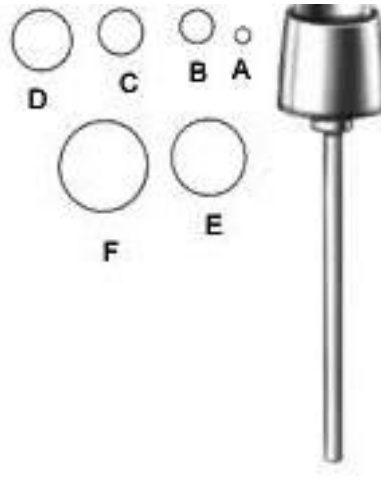

Kaye
JU-17-108-03
 Face-lift Hook
 13 cm,



JU-17-109-02
 Dermal Punch
 5.5 cm,

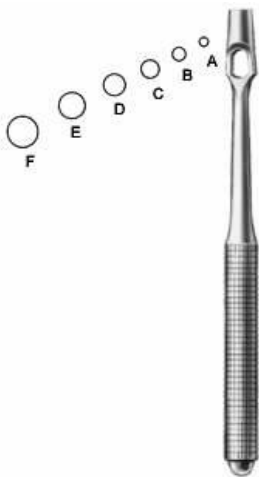

Handle
JU-17-110-00
 8 cm,



Keyes
JU-17-111-02
 Dermal Punch
 11 cm,



Unna
JU-17-113-14
 Comedone Extractor
 14.5 cm,



Saalfeld
JU-17-114-10
 Comedone Extractor
 11 cm,

Dermatology

Saalfeld
JU-17-115-14
 Saalfeld Comedone Extractor
 14.5 cm,



Schamberg
JU-17-116-10
 Comedone Extractor
 9.5 cm,



Katsch
JU-17-117-14
 Comedone Extractor
 16 cm,



Unna-Vidal
JU-17-118-11
 Comedone Extractor
 11.5 cm,



d'Assump?
JU-17-119-15
 Face-lift Forceps
 18 cm,

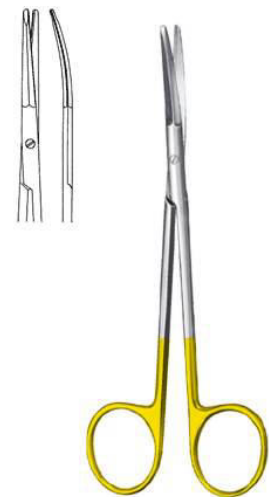

Gregory
JU-17-120-14
 Face-lift Scissors
 14 cm,

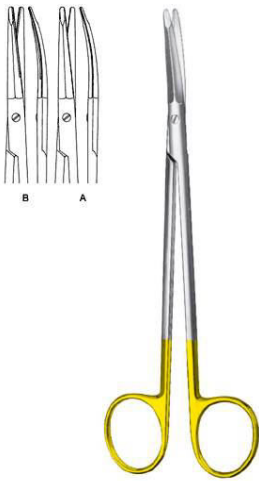
Dermatology

Kaye
JU-17-121-15

 Face-lift Scissors
 15 cm, 18 cm,

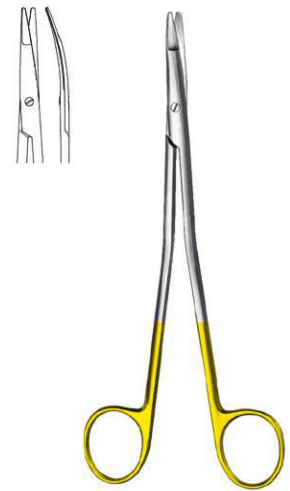
Stella-S
JU-17-122-18

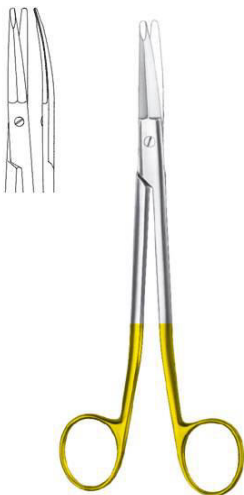
 Face-lift Scissors
 18 cm,

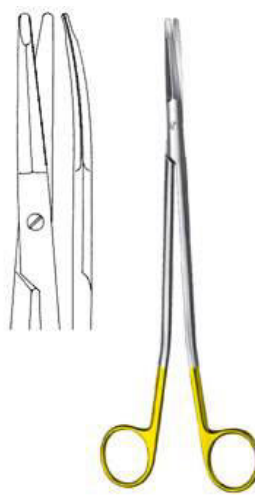
Gorney
JU-17-123-18

 Face-lift Scissors
 18 cm,

Freeman-Kaye
JU-17-124-18

 Face-lift Scissors
 18 cm,

Freeman
JU-17-125-00

 Face-lift Scissors
 23 cm,

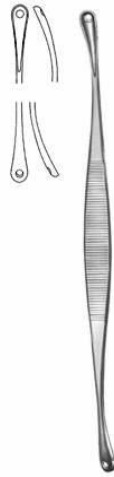
Fox
JU-17-104-01

 Lupus Curette
 14 cm,



Unna
JU-17-112-14
Comedone Extractor
14.5 cm,

Intestines & Stomach

Allis-Baby
JU-18-101-12

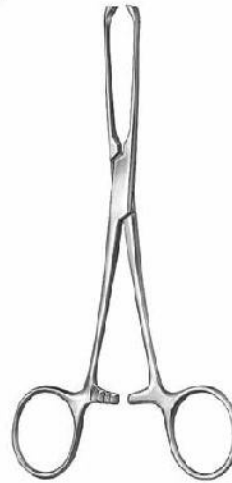
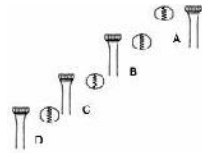
 Intestinal and Tissue Grasping Forceps
13 cm,

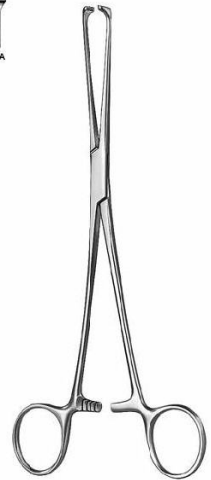
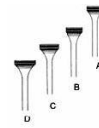
Allis
JU-18-102-15

 Intestinal and Tissue Grasping Forceps
15.5 cm, 19 cm, 25.5 cm,

Allis
JU-18-103-16

 Intestinal and Tissue Grasping Forceps
15.5 cm, 20 cm, 24.5 cm, 30 cm,

Allis-Adair
JU-18-104-15

 Intestinal and Tissue Grasping Forceps
16 cm,

Boys-Allis
JU-18-105-15

 Intestinal and Tissue Grasping Forceps
15.5 cm,

Thoms-Allis
JU-18-106-20

 Intestinal and Tissue Grasping Forceps
20.5 cm,

Intestines & Stomach

Allis
JU-18-107-20

Intestinal and Tissue Grasping Forceps
20 cm,

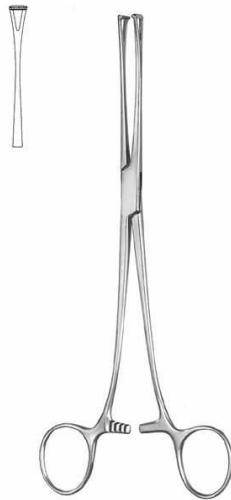

Lockwood
JU-18-108-20

Intestinal and Tissue Grasping Forceps
20 cm,



Williams
JU-18-109-16

Intestinal and Tissue Grasping Forceps
16.5 cm,

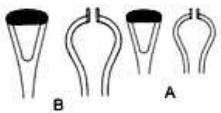

Babcock
JU-18-110-16

Intestinal and Tissue Grasping Forceps
16.5 cm, 21 cm,

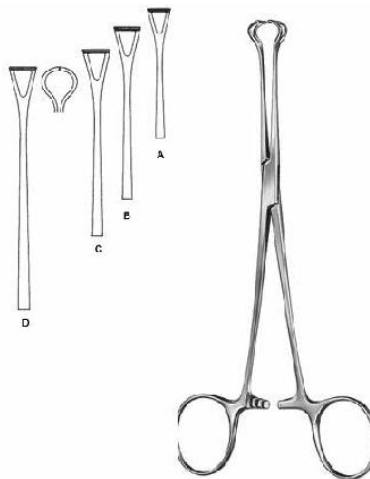

Babcock
JU-18-111-16

Intestinal and Tissue Grasping Forceps
15.5 cm, 17.5 cm, 21 cm, 24 cm,

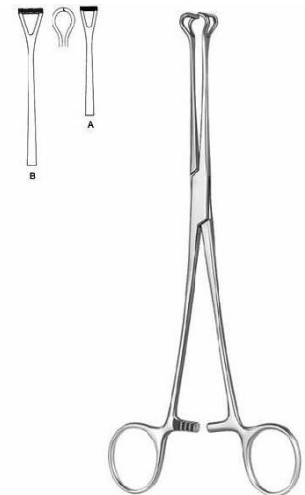

Babcock
JU-18-112-16

Intestinal and Tissue Grasping Forceps
16 cm, 20.5 cm,

Intestines & Stomach

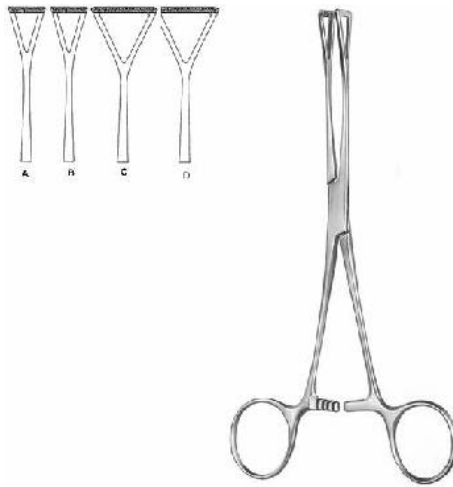

Duval
JU-18-113-20

Intestinal and Tissue Grasping Forceps
20.5 cm,

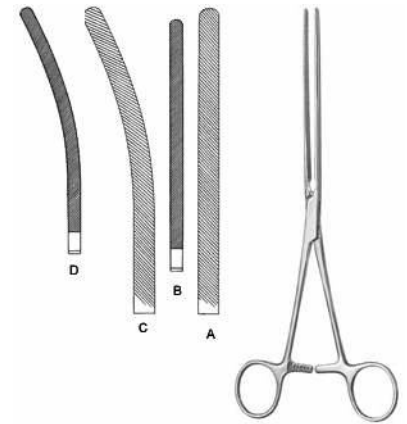

Duval
JU-18-114-18

Intestinal and Tissue Grasping Forceps
18 cm, 20.5 cm, 23 cm,



Doyen
JU-18-115-21
Intestinal Clamp
21.5 cm, 23.5 cm,



Doyen-Baby
JU-18-116-18
Intestinal Clamp
18 cm, 17.5 cm,

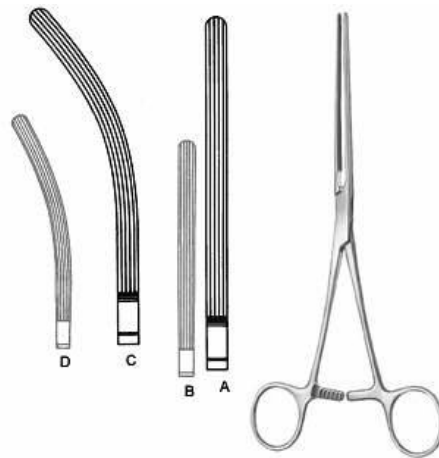

Mayo-Robson
JU-18-117-21
Intestinal Clamp
21.5 cm, 23.5 cm, 23 cm,

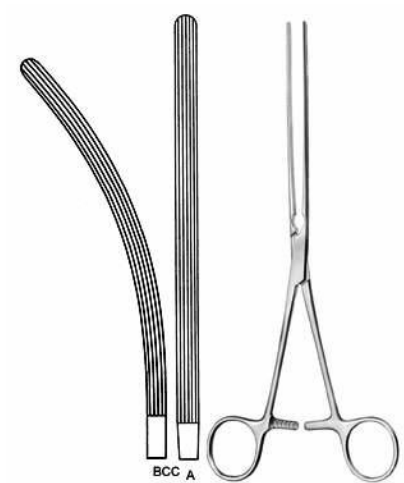

Mayo-Robson
JU-18-118-25
Intestinal Clamp
25.5 cm, 24.5 cm,

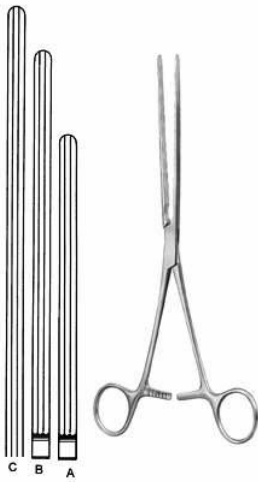
Intestines & Stomach

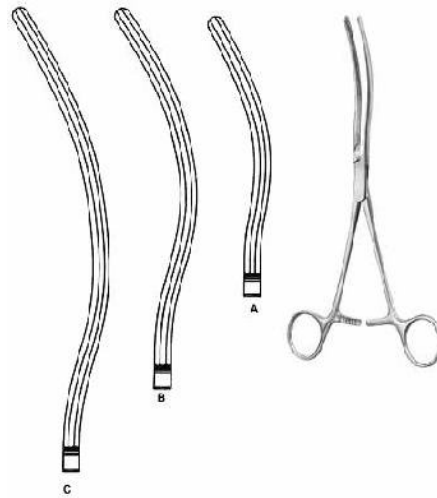
Kocher
JU-18-119-22

 Intestinal Clamp
 22.5 cm, 25 cm, 28.5 cm,

Kocher
JU-18-120-22

 Intestinal Clamp
 22 cm, 24.5 cm, 27.5 cm,

Allen
JU-18-121-16

 Intestinal Clamp
 16 cm,

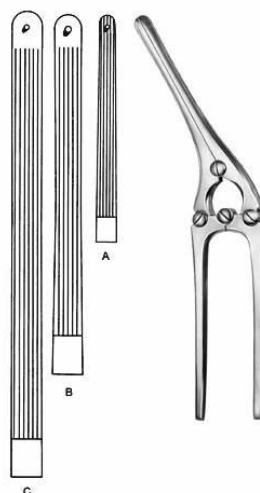
Payr-Baby
JU-18-122-15

 Intestinal and Pylorus Clamp
 15 cm,

Payr
JU-18-123-21

 Intestinal and Pylorus Clamp
 20.5 cm, 29 cm, 34.5 cm,

Stone-Watt
JU-18-124-07

 Intestinal Anastomosis Clamp
 8.5 cm, 10 cm,

Intestines & Stomach

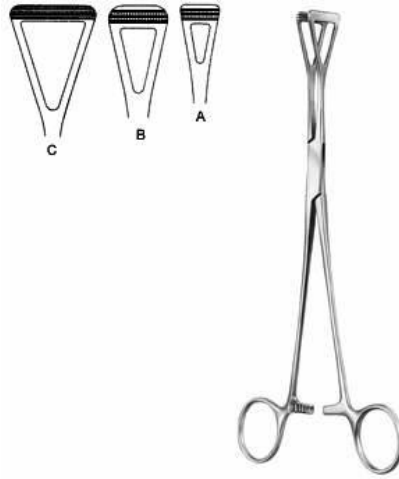

Stone-Watt
JU-18-125-15
 Closing Forceps

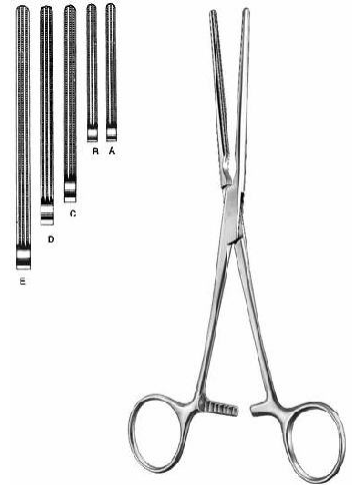

Scheibe
JU-18-126-18
 Organ Grasping Forceps
 18 cm,

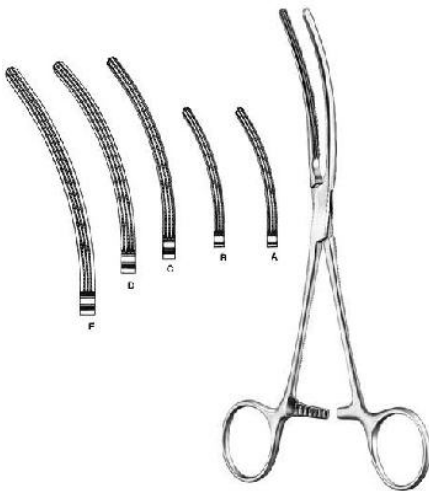

Doyen-Baby
JU-18-127-13
 Intestinal Clamp
 14 cm, 17 cm,



Doyen-Baby
JU-18-128-13
 Intestinal Clamp
 13.5 cm, 17 cm,



Mayo-Robson
JU-18-129-25
 Intestinal Clamp
 26 cm,

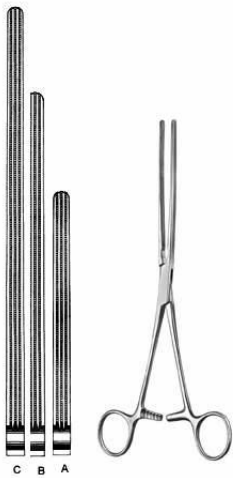

Mayo-Robson
JU-18-130-25
 Intestinal Clamp
 25 cm,

Intestines & Stomach

Kocher
JU-18-131-22
 Intestinal Clamp
 22.5 cm, 28 cm,

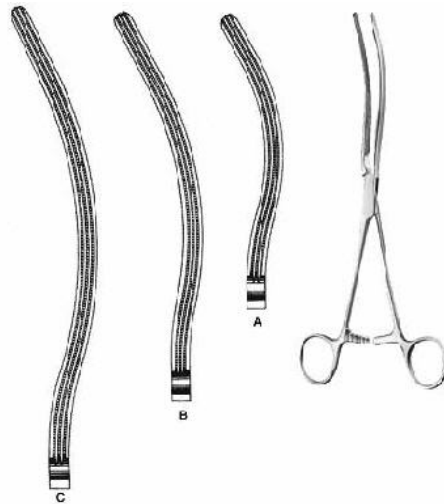

Kocher
JU-18-132-22
 Intestinal Clamp
 22 cm, 25 cm, 27.5 cm,

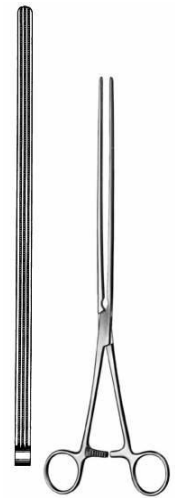

Scudder
JU-18-133-33
 Intestinal Clamp
 33.5 cm,

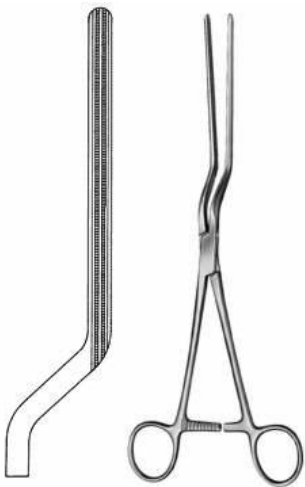

Brunner
JU-18-134-24
 Sigmoid Anastomosis Forceps
 27 cm,



Hayes
JU-18-135-26
 Sigmoid Anastomosis Forceps
 27 cm, 28 cm,



Veidenheimer
JU-18-136-23
 Sigmoid Anastomosis Forceps
 25 cm,

Intestines & Stomach

Fehland
JU-18-137-24
 Sigmoid Anastomosis Forceps
 24 cm,

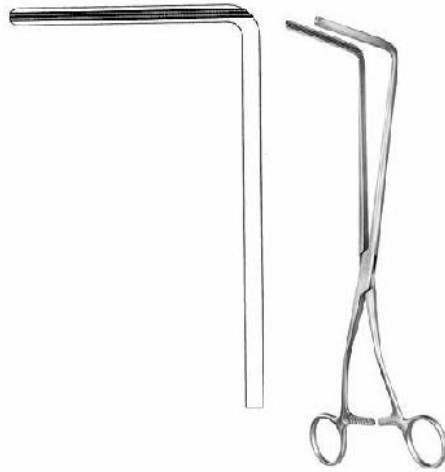

Resano
JU-18-138-30
 Sigmoid Anastomosis Forceps
 28 cm,



Sims
JU-18-139-15
 Rectal Speculum
 15.5 cm,



Sims
JU-18-140-15
 Rectal Speculum
 15.5 cm,



Mathieu
JU-18-141-19
 Rectal Speculum
 19 cm,



Alan-Parks
JU-18-142-00
 Alan-Parks
 14 cm,

Intestines & Stomach

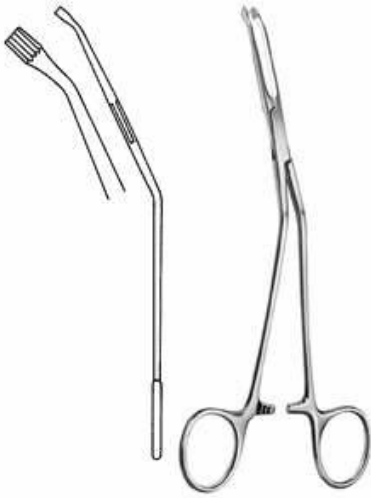

McGinvey

JU-18-143-19

Hemorrhoidal Grasping Forceps
19 cm,



JU-18-144-00

Handle for biopsy forceps



JU-18-145-38

Rectal Biopsy Forceps

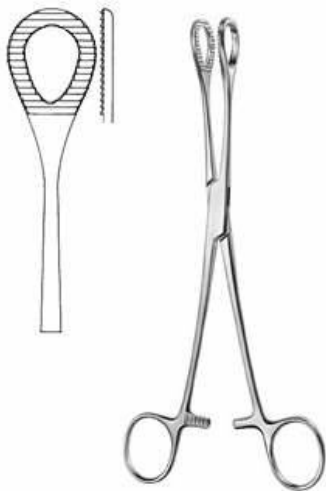

Heywood-Smith

JU-18-146-21

Polypus Grasping Forceps
21 cm,

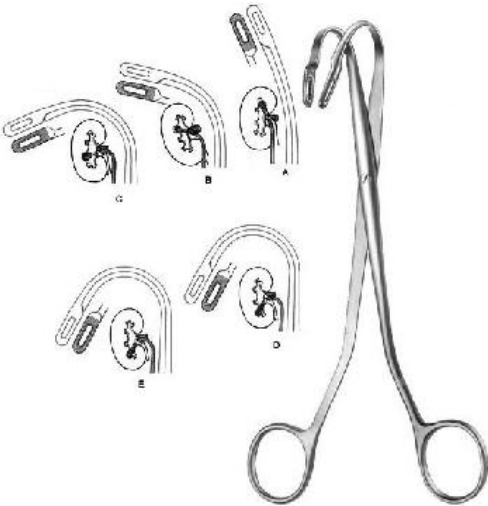
Randall
JU-19-101-23 A

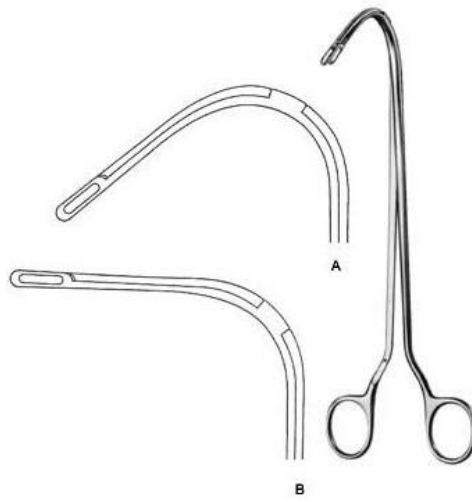
 Kidney Stone Forceps
 23 cm Fig. 1, 21 cm Fig. 2, 19 cm Fig. 3,

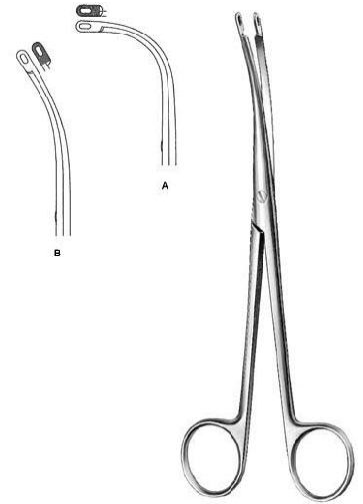
Randall
JU-19-102-23 A

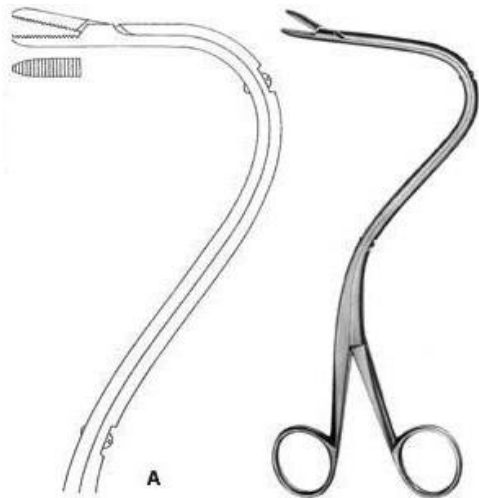
 Kidney Stone Forceps
 23 cm, 24.5 cm,

Heiming
JU-19-103-16 A

 Kidney Stone Forceps
 16 cm Fig. 1, 17 cm Fig. 2,

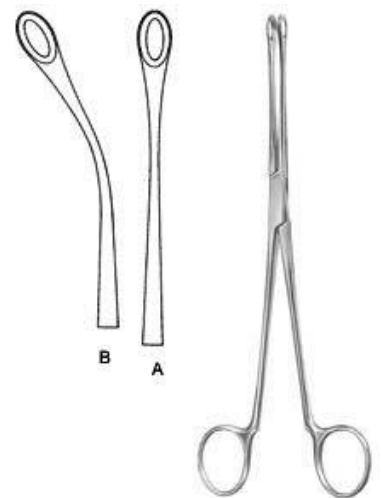
Elsasser
JU-19-104-01 A

 Nephrostomy Forceps
 21 cm Fig. 1, 21 cm Fig. 2,

Bakes
JU-19-105-01 A

 Gall Duct Dilator
 32 cm,

Blake
JU-19-106-20 A

 Gall Stone Forceps
 21 cm,



Mayo-Blake
JU-19-107-20
 Gall Stone Forceps
 21 cm,



Mayo-Blake
JU-19-108-20
 Gall Stone Forceps
 21 cm,



Mixer
JU-19-109-22
 Gall Stone Forceps
 21.5 cm,



Desjardins
JU-19-110-23 A
 Gall Stone Forceps
 23 cm,

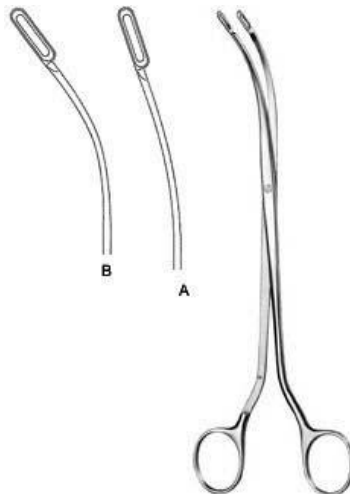

Desjardins
JU-19-111-24 A
 Gall Stone Forceps



Luer-Korte
JU-19-112-01 A
 Gall Stone Scoop
 32 cm Fig. 0, 32 cm Fig. 00, 32 cm Fig.
 000, 32 cm Fig. 1, 32 cm Fig. 2, 32 cm Fig.
 3, 32 cm Fig. 4,

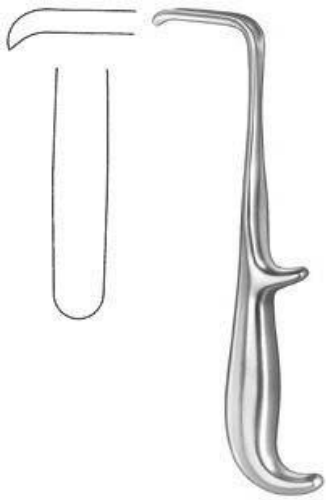

Young
JU-19-113-21
 Prostatic Retractor
 21.5 cm,



Young
JU-19-114-22
 Prostatic Retractor
 20.5 cm,



Young
JU-19-115-21
 Prostatic Retractor
 22 cm,

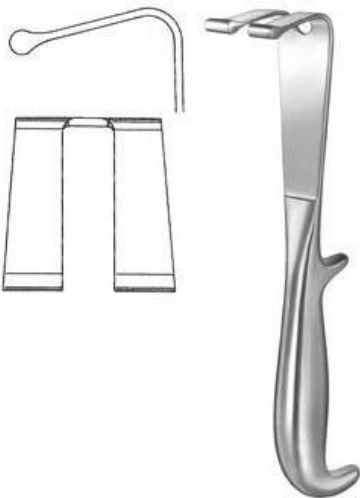

Young
JU-19-116-22
 Prostatic Retractor
 21.5 cm,



Millin
JU-19-117-24
 Capsule Forceps
 24.5 cm,

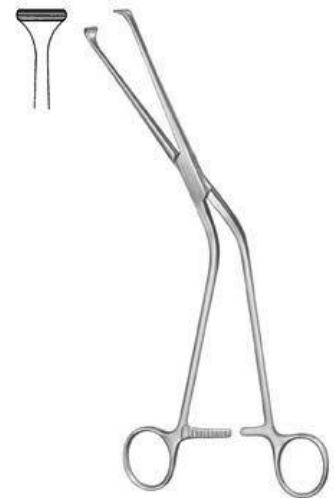

Millin
JU-19-118-24
 Capsule Forceps
 22 cm,

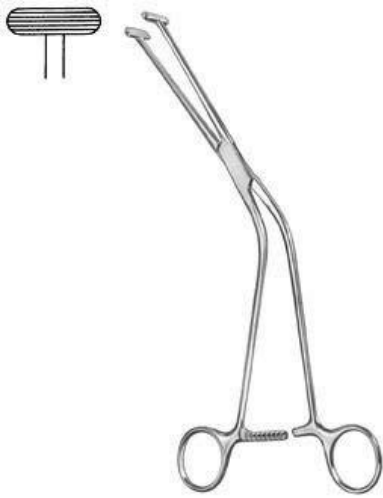

Millin
JU-19-119-23
 Capsule Forceps
 24.5 cm,



Millin
JU-19-120-23
 Capsule Forceps
 22 cm,

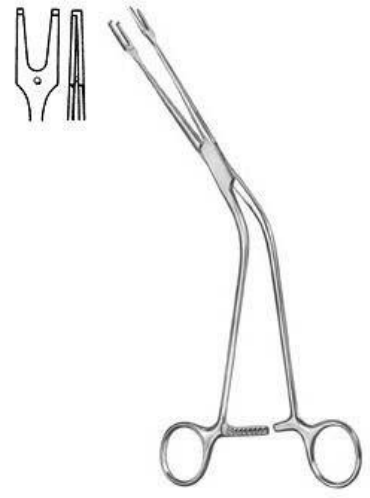

Millin
JU-19-121-24
 Ligature Carrying Forceps
 24.5 cm,



Millin
JU-19-122-00
 Bladder Neck Spreader
 29,



Thomson-Walker
JU-19-123-00
 Bladder Retractor



Judd-Masson
JU-19-124-00
 Bladder Retractor

Urology



Millin
JU-19-125-00 A
 Bladder Retractor



Legueu
JU-19-126-27
 Bladder Spatula
 24 cm 35 mm,

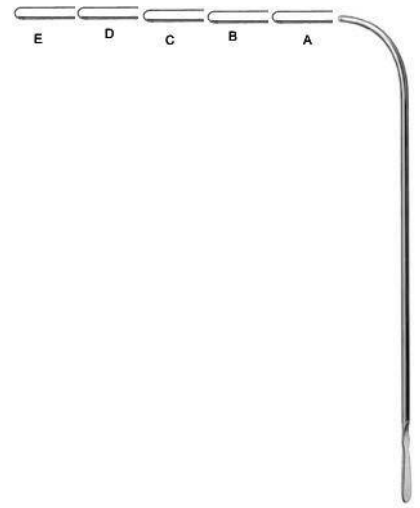

Van Buren
JU-19-127-00 A
 Urethral Sound
 27.5 cm,

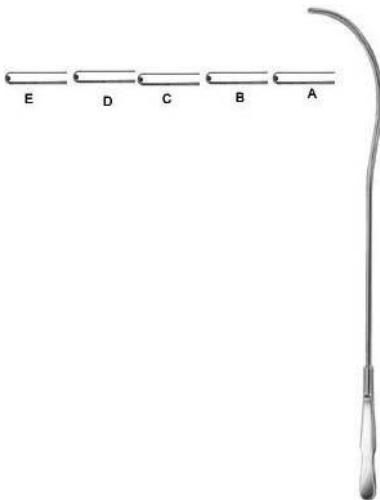

Guyon
JU-19-128-10 A
 Urethral Sound
 26 cm,



Foreign body forceps
JU-19-129-11
 Foreign body forceps
 20 cm, 28 cm,

Gynecology

Cusco
JU-20-101
 Vaginal Speculum
 75 x 32 mm, 85 x 35 mm,



Cusco
JU-20-102-01
 Vaginal Speculum
 75 x 18 mm,



Cusco
JU-20-103-01
 Vaginal Speculum
 80 x 22 mm, 100 x 25 mm, 105 x 27 mm,



Cusco
JU-20-104-01
 Vaginal Speculum
 75 x 34 mm, 85 x 37 mm,



Collin
JU-20-105-01
 Vaginal Speculum
 85 x 30 mm, 100 x 35 mm,



Pederson
JU-20-106-01
 Vaginal Speculum
 75 x 13 mm, 100 x 22 mm,

Gynecology

Grave
JU-20-107-01

 Vaginal Speculum
 75 x 20 mm, 95 x 35 mm,

Semm
JU-20-108-01

 Vaginal Speculum
 100 x 20 mm, 105 x 27 mm,

Sims
JU-20-109-01

 Vaginal Speculum
 65 x 25 mm, 70 x 30 mm,

Kristeller
JU-20-110-01

 Vaginal Speculum
 70 x 27 mm,

Kristeller
JU-20-111-01

 Vaginal Retractor
 75 x 23 mm,

Kristeller
JU-20-112-01

 Vaginal Speculum
 Size 1,



Kristeller
JU-20-113-01
 Vaginal Speculum
 105 x 18 mm,



Kristeller
JU-20-114-01
 Vaginal Retractor
 110 x 14 mm,



Kristeller
JU-20-115-01
 Vaginal Speculum
 Size 1,

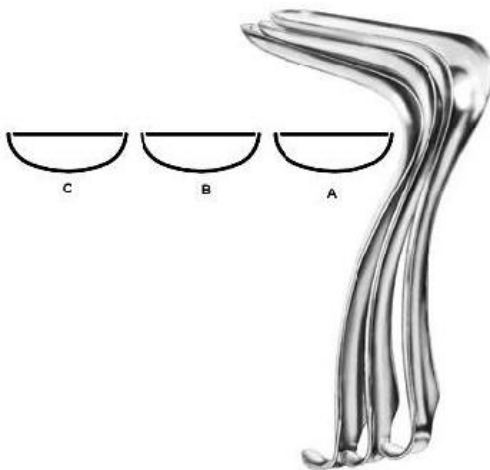

Kristeller
JU-20-116-01
 Vaginal Speculum
 105 x 26 mm,

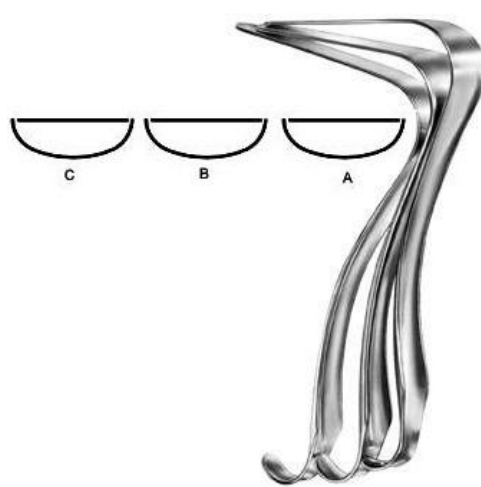

Kristeller
JU-20-117-01
 Vaginal Retractor
 115 x 22 mm, 115 x 24 mm,

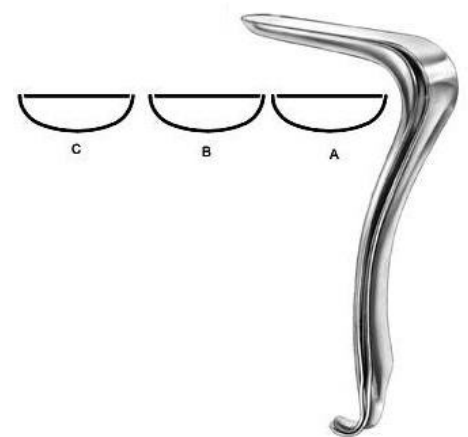

Kristeller
JU-20-118-01
 Vaginal Speculum
 Size 1,

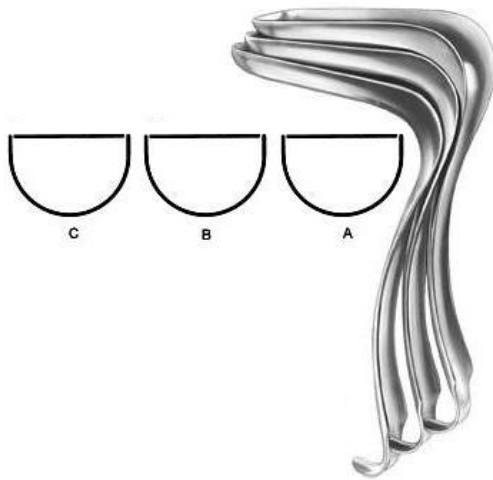

Kristeller
JU-20-119-01
 Vaginal Speculum
 110 x 27 mm,

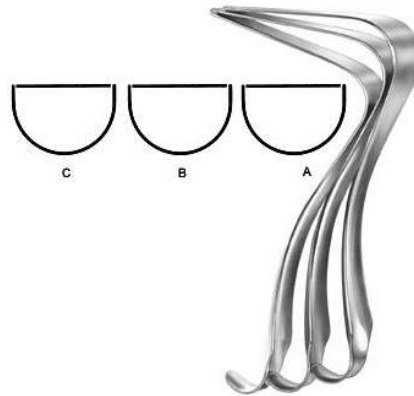

Kristeller
JU-20-120-01
 Vaginal Retractor
 115 x 23 mm,

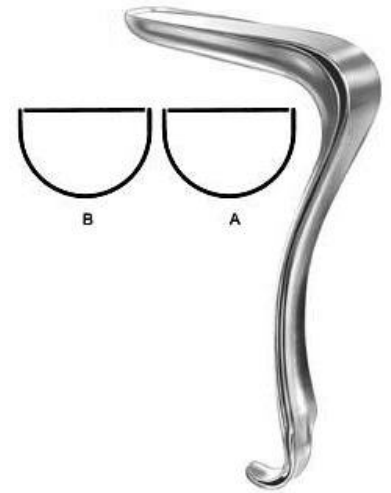

Kallmorgen
JU-20-121-01
 Vaginal Speculum



Kallmorgen
JU-20-122-01
 Vaginal Retractor
 70 x 40 mm Fig. 1, 90 x 40 mm Fig. 2,



Kallmorgen
JU-20-123-01
 Vaginal Speculum
 70 x 33 mm, 90 x 33 mm,

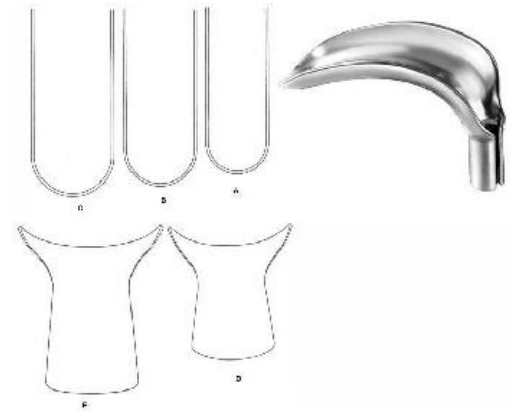

Scherbak
JU-20-125-00
 Vaginal Speculum
 Size 1,

Gynecology

Auvard
JU-20-126-22
 Vaginal Speculum
 80 x 43 mm,



Weissbarth
JU-20-127-24
 Vaginal Speculum
 21 cm 80 x 42 mm,



Breisky
JU-20-128-20
 Vaginal Speculum
 29 cm 100 x 20 mm, 29 cm 100 x 25 mm,



Kogan
JU-20-129-24
 Endocervical Speculum
 25 cm 70 x 30 mm,



Kogan
JU-20-130-24
 Endocervical Speculum
 24.5 cm,



Hegar
JU-20-131-24
 Uterine Dilator
 18.5 cm 1,0,



Hegar
JU-20-132-02
 Uterine Dilator
 20 cm 1,0,



Hank
JU-20-133-10
 Uterine Dilator
 26.5 cm Fig. 9/10,



Sims
JU-20-134-32
 Uterine Sound
 33 cm,



Valleix
JU-20-135-25
 Uterine Sound
 29.5 cm,



Braun
JU-20-136-26
 Uterine Depressor
 27.5 cm,



Schroder
JU-20-137-25
 Uterine Tenaculum Forceps
 25.5 cm,



Braun
JU-20-138-25
 Uterine Tenaculum Forceps
 26 cm,



Duplay
JU-20-139-28
 Uterine Tenaculum Forceps
 25.5 cm,



Beacham
JU-20-140-26
 Amniotome
 26 cm,



Skene
JU-20-141-24
 Uterine Tenaculum Forceps
 24 cm,

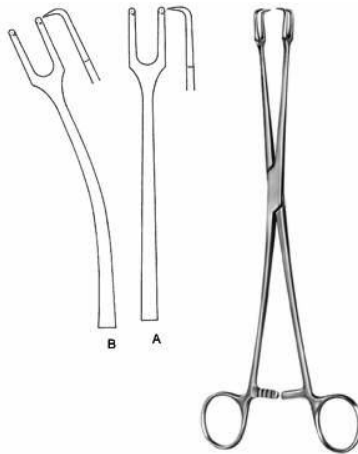

Schroder
IN-20-142-24
 Uterine Tenaculum Forceps
 25 cm,



Teale
JU-20-143-23
 Uterine Tenaculum Forceps
 23.5 cm,

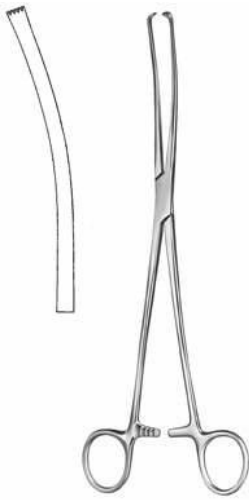

Iowa
JU-20-144-26
 Uterine Tenaculum Forceps
 26 cm,



Museux
JU-20-145-24
 Uterine Tenaculum Forceps
 24 cm,



Jacobs
JU-20-146-21
 Uterine Tenaculum Forceps
 21 cm,

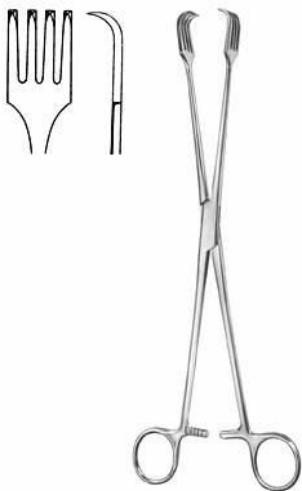

JU-20-147-26
 Uterine Tenaculum Forceps
 26.5 cm,



Braun
JU-20-148-16
 Uterine Tenaculum Forceps
 16 cm,

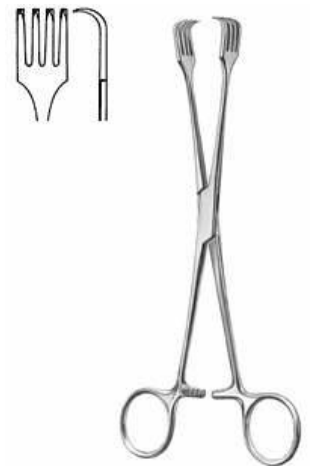

Czerny
JU-20-149-21
 Uterine Tenaculum Forceps
 21 cm,



Kelly
JU-20-150-32
 Uterine Polypus Forceps
 32 cm,



Noto
JU-20-151-27
 Uterine Polypus Forceps
 27 cm,

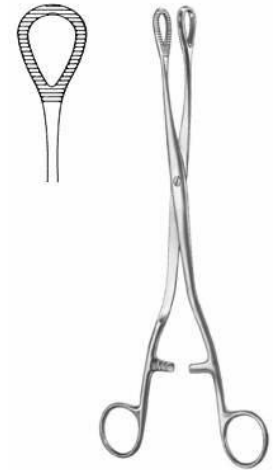

Heywood-Smith
JU-20-152-25
 Uterine Polypus Forceps
 25 cm,



Doyen
JU-20-153-17
 Myoma Screw
 17 cm,



Doyen
JU-20-154-17
 Myoma Screw
 14.5 cm,

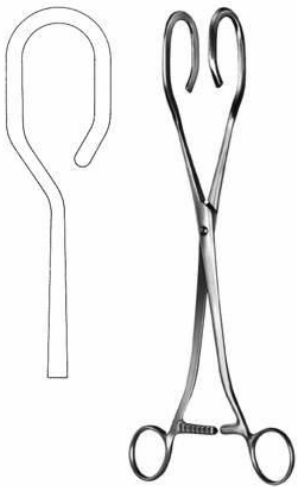

Segond
JU-20-155-27
 Myoma Knife
 28 cm,

Gynecology

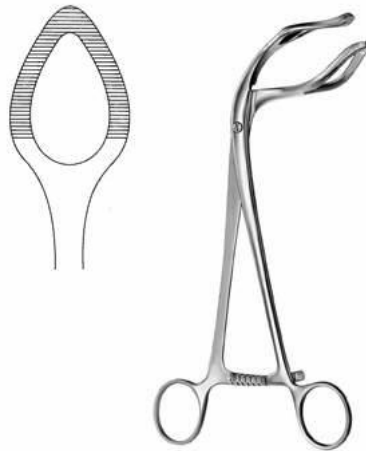
Dartigues
JU-20-156-27

 Uterine Seizing Forceps
28 cm,

Somer
JU-20-157-27

 Uterine Seizing Forceps
22.5 cm,

Collin
JU-20-158-25

 Uterine Seizing Forceps jaw 40 mm wide
26 cm,

Ayre
JU-20-159-23

 Conization Knife cutting edge 3,6 mm wide
23.5 cm,

Emmett
JU-20-160-03

 Fistula Hook
22 cm Fig.3,

Simon
JU-20-161-22

 Fistula Hook
21.5 cm,



Simon
JU-20-162-22
 Fistula Hook
 21.5 cm,



Novak
JU-20-163-23
 Suction Curette 4 mm ?
 24.5 cm,



Kevorkian
JU-20-164-23
 Uterine Biopsy Curette 6,0 mm ?
 30 cm,



Munchen
JU-20-165-27
 Uterine Biopsy Curette 4,8 mm ?
 27 cm,



Gellhorn
JU-20-166-23
 Uterine Biopsy Forceps jaw 8,6 mm wide
 24 cm,

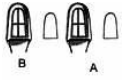

Faure
JU-20-167-21
 Faure Uterine Biopsy Forceps
 21 cm,

Gynecology

Schubert
JU-20-168-21

Uterine Biopsy Forceps jaw 4,8 mm wide
21.5 cm, 28 cm,

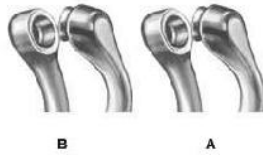

Thoms-Gaylor
JU-20-169-22

Uterine Biopsy Forceps jaw 5,6 mm ?
21 cm, 23.5 cm,

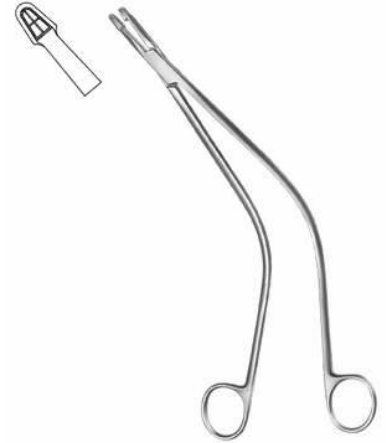

Schubert
JU-20-170-26

Schubert Uterine Biopsy Forceps
25.5 cm,

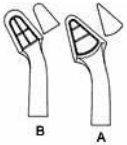

Van Doren
JU-20-171-24

Uterine Biopsy Forceps jaw 4,9 mm wide
27 cm, 25.5 cm,



Alexander
JU-20-172-28

Uterine Biopsy Forceps jaw 5,1 mm wide
28 cm,



Kevorkian
JU-20-173-32

Uterine Biopsy Forceps
25 cm,

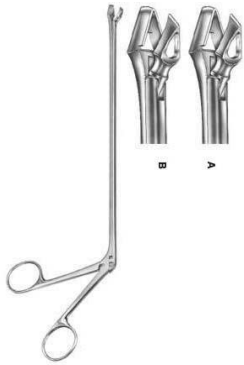
Gynecology

Schumacher
JU-20-174-01

Uterine Biopsy Forceps jaw 4,6 / 5,4 mm
wide
24 cm,



Schumacher
JU-20-175-00

Uterine Biopsy Forceps
25 cm,



JU-20-176-22

IUP Grasping Forceps 3 mm ?
22 cm,

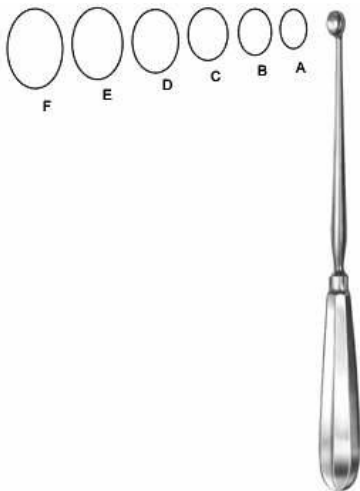

Simon

JU-20-177-01

Uterine Scoop
24.5 cm 9,8 x 8,6 mm, 24.5 cm 11,6 x 8,3
mm,



Simon

JU-20-178-01

Uterine Scoop
30 cm 9,8 x 8,6 mm, 30 cm 11,6 x 8,3 mm,



Recamier

JU-20-179-05

Uterine Curette
31 cm Fig. 00 5 mm, 31 cm Fig. 0 6 mm,

Gynecology

Recamier
JU-20-180-05

Uterine Curette

31 cm Fig. 00 5 mm, 31 cm Fig. 0 6 mm,



Sims

JU-20-181-05

Uterine Curette

31 cm Fig. 00 5 mm, 31 cm Fig. 0 6 mm,

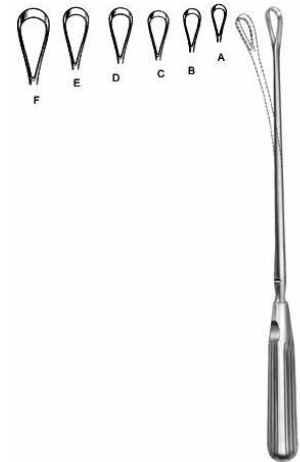

Sims

JU-20-182-05

Uterine Curette

31 cm Fig. 00 5 mm, 31 cm Fig. 0 6 mm,



JU-20-183-03

Suction Curette

29 cm 3,0 mm ?, 29 cm 4,5 mm ?, 29 cm 6,0 mm ?,



Douay

JU-20-184-01

Douay

20 cm, 25 cm, 30 cm, 35 cm, 40 cm,



Thomas-Gaylor

JU-20-184-02

Thomas-Gaylor

22 cm, 24 cm,

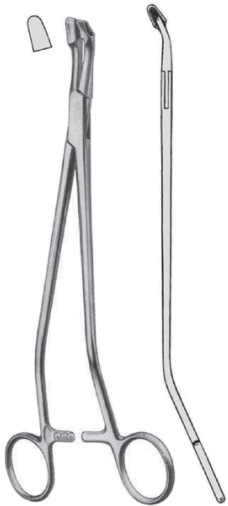

Van Doren
JU-20-184-03
 Van Doren
 24 cm,



Schumacher-Van Doren
JU-20-184-04
 Schumacher-Van Doren
 24 cm/6mm 4mm,



Gellhorn
JU-20-184-05
 Gellhorn
 23 cm,



Schubert
JU-20-184-06
 Schubert
 21 cm, 28 cm,



Schubert
JU-20-184-07
 Schubert
 26 cm,

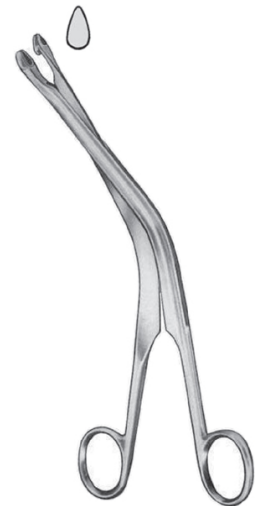

Faure
JU-20-184-08
 Faure
 21 cm, 24 cm,

Gynecology

ALEXANDER
JU-20-184-09
 ALEXANDER
 20 cm, 28 cm,



TISCHLER
JU-20-184-10
 TISCHLER
 23 cm,



TISCHLER-MINI
JU-20-184-11
 TISCHLER-MINI
 23 cm,



KEVORKIAN-PACIFIC
JU-20-184-12
 KEVORKIAN-PACIFIC
 23 cm,

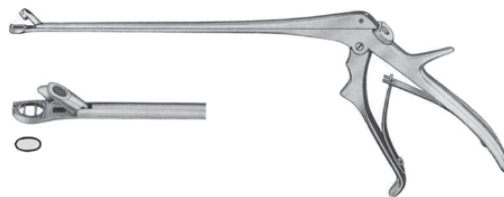

TISCHLER (Baggish)
JU-20-184-13
 TISCHLER (Baggish)
 23 cm,

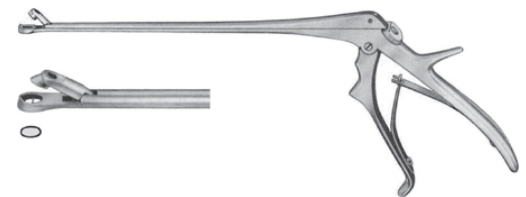

TISCHLER-BURKE
JU-20-184-14
 TISCHLER-BURKE
 23 cm,

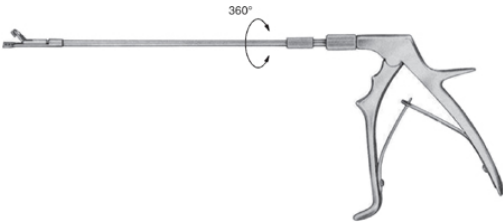

TOWNSEND
JU-20-184-15
 Handle only
 straight
 curved up
 curved down

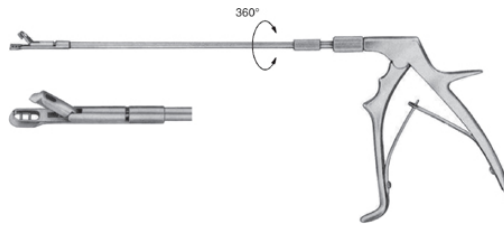

TOWNSEND-TISCHLER
JU-20-184-16
 complete
 tip only
 360°,

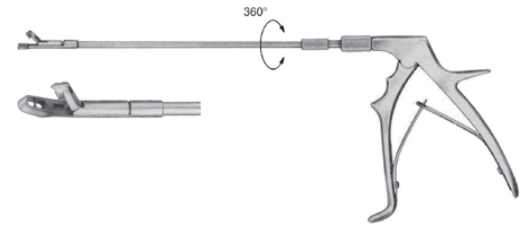

TOWNSEND-TISCHLER
JU-20-184-17
 complete
 tip only
 360°,

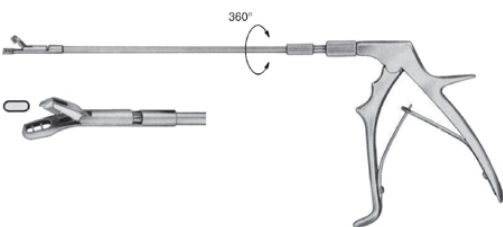

TOWNSEND-TISCHLER
JU-20-184-18
 complete
 tip only
 360°,

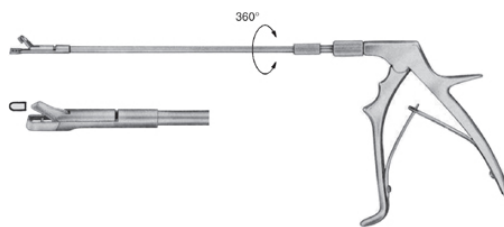

TOWNSEND-MINI
JU-20-184-19
 complete
 tip only
 360°,

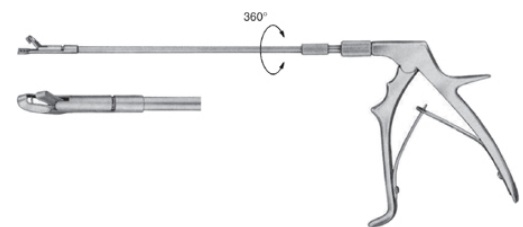

TOWNSEND-MINI
JU-20-184-20
 complete
 tip only
 360°,

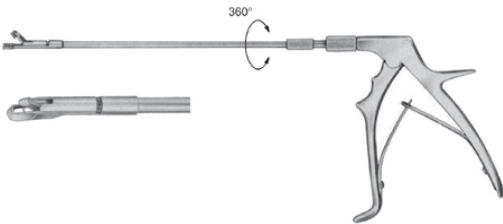
TOWNSEND-MINI
JU-20-184-21

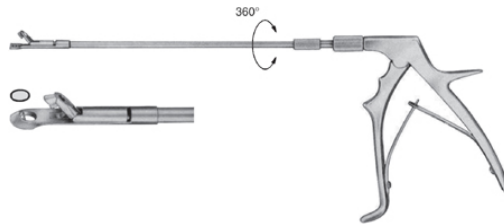
 complete
tip only
360°,

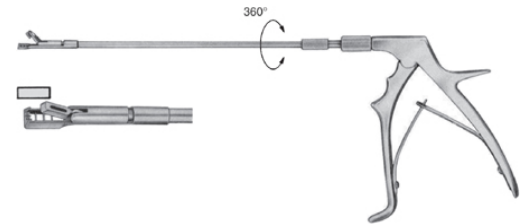
TOWNSEND-BURKE
JU-20-184-22

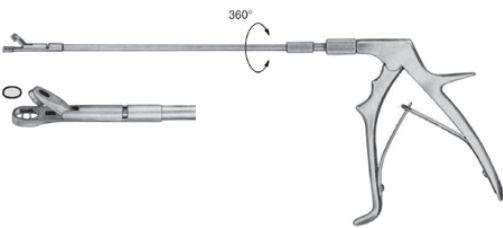
 complete
tip only
360°,

TOWNSEND-KEVORKIAN
JU-20-184-23

 complete
tip only
360°,

TOWNSEND-KRAUSE
JU-20-184-24

 complete
tip only
360°,

EPPENDORF
JU-20-184-25

 EPPENDORF
20 cm, 23 cm,

WITTNER
JU-20-184-26

 straight
curved
23 cm,



SCHUMACHER
JU-20-184-27
 SCHUMACHER
 24 cm,



SCHUMACHER
JU-20-184-28
 SCHUMACHER
 24 cm,



SCHUMACHER
JU-20-184-29
 xtension canula 20 cm
 tip only
 Handle only
 24 cm #1,



KEVORKIAAN
JU-20-184-30
 KEVORKIAAN
 25 cm,



BERGER
JU-20-184-31
 BERGER
 19 cm / 3mm, 19 cm / 5mm,

Obstetrics

Martin
JU-21-101-34
 Pelvimeter cm, inch scale
 34 cm,



Nagele
JU-5-102-36
 Obstetrical Forceps
 35 cm, 40.5 cm,



Simpson
JU-5-103-30
 Obstetrical Forceps
 31 cm,



Wrigley
JU-5-104-28
 Obstetrical Forceps
 28 cm,



Simpson
JU-21-105-36
 Obstetrical Forceps
 36.5 cm,

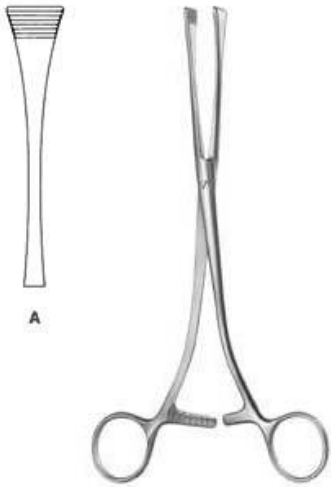

Kielland
JU-21-106-41
 Obstetrical Forceps
 42 cm,

Obstetrics

Green-Armytage
JU-21-107-21
 Uterine Clamp
 21 cm,



Sellheim
JU-21-108-28
 Obstetrical Lever
 32 cm,

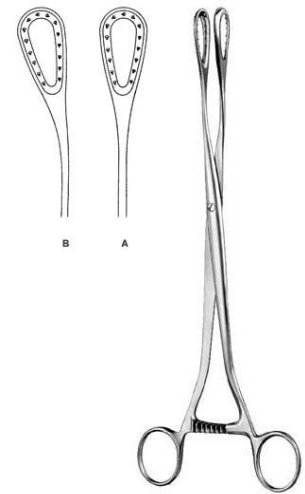

Sanger
JU-21-109-27
 Placenta and Ovum Forceps
 27.5 cm, 27 cm,

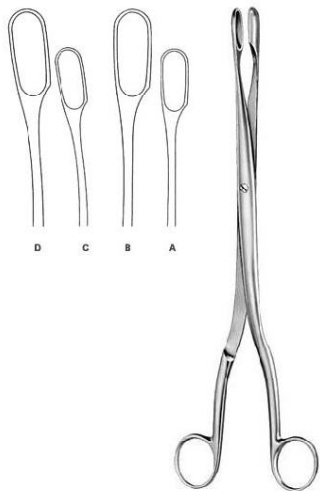

Winter
JU-21-110-01
 Placenta and Ovum Forceps
 28 cm Fig. 1, 28 cm Fig. 2,

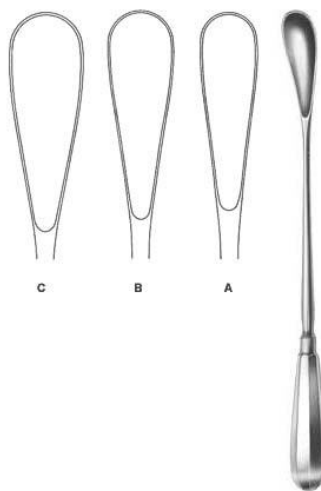

Cuzzi
JU-21-111-01
 Placenta Scoop
 30 cm 14,5 mm, 30 cm 18 mm,

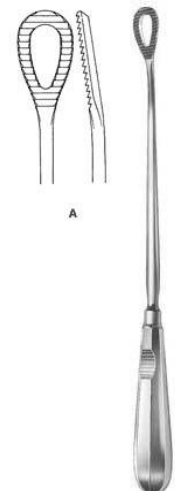

Pestallozza
JU-21-112-30
 Placenta Scoop
 30 cm,

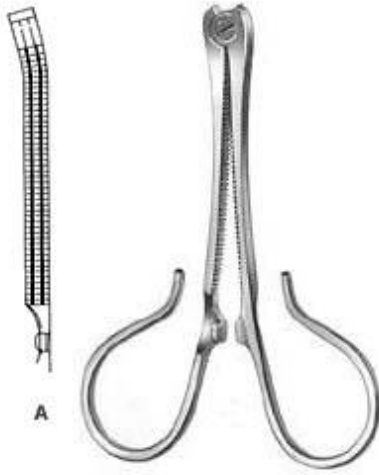

Kane
JU-21-113-08
Umbilical Cord Clamp
8.5 cm,



Collin
JU-21-114-09
Umbilical Cord Clamp
8.5 cm,



Irrigator
JU-23-101-10
Size 1,



Round Bowl
JU-23-102-16
220 mm x 70 mm, 400 mm x 150 mm,



JU-23-103-33
Round Bowl
? x h 6,00 l,



Flat Dish
JU-23-104-11
? x h 0,20 l,



Lid only
JU-23-105-11
Size 1,



Stainless Steel
JU-23-106-04
? x h 0,30 l,

Sterilization

Round Dish
JU-23-107-11

? x h 0,30 l, ? 128 x 38 mm 0,40 l,



Flat Dish
JU-23-108-11

? x h 0,15 l,



Measurer
JU-23-109-01
graduated inside
100cc = 0,1 l,



Measurer
JU-23-110-02
Graduated Inside
0,25 l, 0,50 l,



Petri Dish
JU-23-111-10
with Lid ? x h



Petri Dish
JU-23-112-09
without lid ? x h
Size 1,

Sterilization



Lid for Petri Dishes
JU-23-113-10
Size 1,



Universal Tray
JU-23-114-23
l x b x h,



Instrument Tray
JU-23-115-21
l x b x h,



Universal Tray
JU-23-116-23
l x b x h,



Round Bowl
JU-23-117-22
? x h,



Metal Jar
JU-23-118-30
? 30mm x 90 mm, ? 50mm x 100 mm,



Instrument Box
JU-23-119-16
 lid with knob
 l x b x h,



Instrument Box
JU-23-120-16
 lid with knob
 l x b x h,



Instrument Box
JU-23-121-20
 l x b x h,



Round Metal Box
JU-23-122-06
 ? 75 mm x 75 mm, ? 100 mm x 60 mm,



Medicine Cup Graduated Inside
JU-23-123-25
 25 ccm,



Medicine Cup Graduated Inside
JU-23-124-50
 50 ccm,



Tablet Tray
JU-23-125-75
? 75 mm x 12 mm,



Metal Cup
JU-23-126-90
? 90 mm x 90 mm,



Denture Cup
JU-23-127-75
? 75 mm x 50 mm,



Insert for Cup
JU-23-128-75
? 73 mm x 75 mm,



Kidney Dish
JU-23-129-17
l x b x h,



Placenta Pan
JU-23-130-36
Size 1,



Waste Cotton Collector
JU-23-131-01
? 50 mm x 75 mm,



Spirit Lamp
JU-23-132-07
120 ccm,

Bone Surgery



Charrière
JU-7-102-35
Amputation Saw
35 cm,



Langenbeck
JU-7-103-23
Amputation Saw
24.5 cm,



Charrière
JU-7-104-27
Amputation Saw
26.5 cm,



JU-7-105-14
Reamer
13.5 cm,



Perthes
JU-7-106-18
Reamer
18 cm,

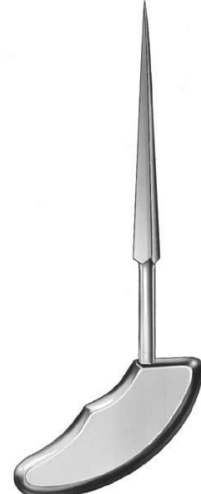

Perthes
JU-7-107-21
Reamer
21.5 cm,

Bone Surgery

JU-7-108-14
Reamer
14 cm,



JU-7-111-18
Flat Trephine

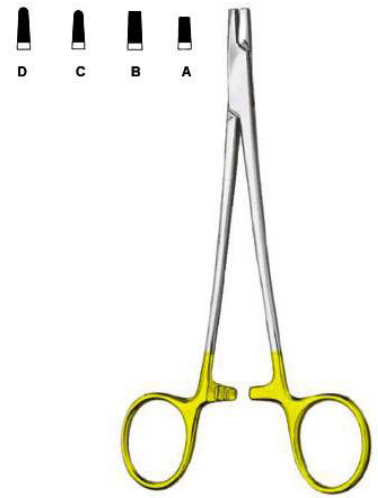

JU-7-112-01
Wire Twisting Forceps
15.5 cm, 18 cm, 20 cm,



JU-7-113-15
Wire Twisting Forceps
15.5 cm,



JU-7-114-17
Flat Nose Plier
18.5 cm,



JU-7-115-18
Wire Twisting Forceps
19 cm,

Bone Surgery

JU-7-116-15
Combi-Flat Nose Plier
15 cm,



JU-7-117-01
Flat Nose Plier
18 cm,

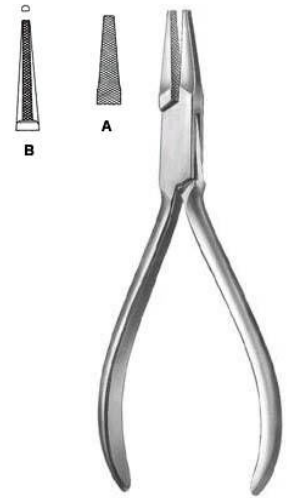

JU-7-118-14
Flat Nose Plier
13.5 cm,



Hackstock
JU-7-119-16
Flat Nose Plier
16 cm,



JU-7-120-01
Flat Nose Plier
17.5 cm,



JU-7-121-18
Wire Cutting Pliers
18.5 cm,

Bone Surgery



JU-7-122-15
Wire Cutting Pliers
15 cm,

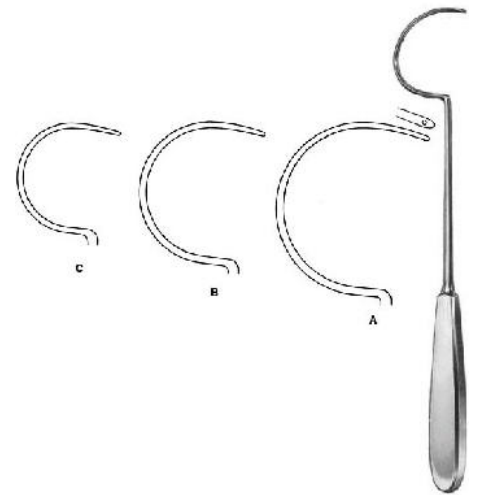

JU-7-123-18
Wire Cutting Pliers
17.5 cm,

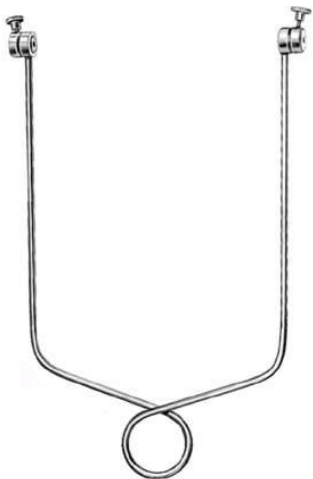

Demel
JU-7-124-18
Wire Guide
31 cm Fig. 1, 29 cm Fig. 2, 28 cm Fig. 3,



Bohler
JU-7-125-15
Extension Bow



Kirschner
JU-7-126-01
Extension Bow
18.5 cm, 26.5 cm,



JU-7-127-06
Traction Hook for Extension Bows

Bone Surgery

Kirschner
JU-7-128-06
Wire Drill
6 cm, 12 cm,



Kirschner
JU-7-129-06
Wire Drill
14 cm, 16 cm,



Kirschner
JU-7-130-10
Wire Drill
31 cm,



Kirschner
JU-7-131-10
Wire Drill
6 cm, 12 cm, 18 cm,



Kirschner
JU-7-132-10
Wire Drill
31 cm,

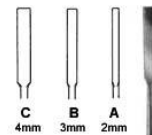

Buckley
JU-7-133-02
Chisel
16 cm,

Bone Surgery



Buckley
JU-7-134-02
 Gouge
 16 cm,



Stout
JU-7-135-03
 Bone Chisel
 21 cm,



JU-7-136-04
 Bone Chisel
 18 cm,



JU-7-137-04
 Bone Chisel
 18 cm,



JU-7-138-04
 Bone Chisel
 17 cm,

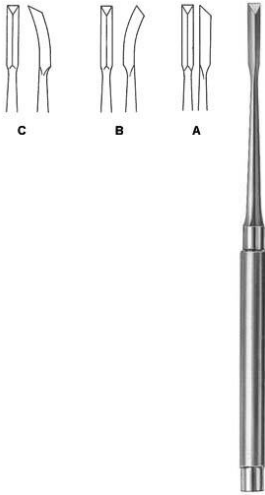

JU-7-139-04
 Bone Chisel
 17 cm,

Bone Surgery

Gardner
JU-7-140-01
 Bone Chisel
 17 cm 4mm,



Snyder-O.S.U.
JU-7-141-03
 Bone Chisel
 16.5 cm 3mm, 16.5 cm 5.5mm,



O.S.U.
JU-7-142-01
 one Chisel
 17 cm 7mm,



O.S.U.
JU-7-143-01
 one Chisel
 17 cm 9mm,



JU-7-144-08
 Osteotome
 13.5 cm 8mm, 13.5 cm 10mm, 13.5 cm 12mm, 13.5 cm 14mm, 13.5 cm 16mm,

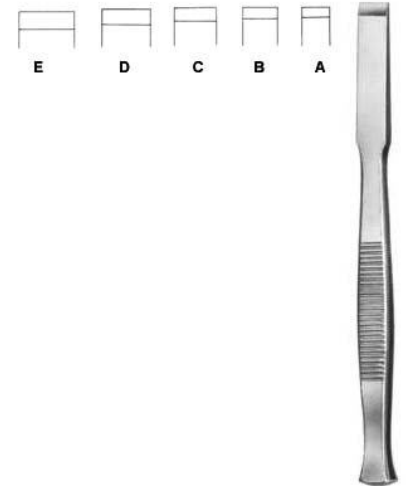

JU-7-145-08
 Chisel
 13.5 cm 8mm, 13.5 cm 10mm, 13.5 cm 12mm, 13.5 cm 14mm, 13.5 cm 16mm,

Bone Surgery

JU-7-146-08

Gouge

13.5 cm 8mm, 13.5 cm 10mm, 13.5 cm 12mm, 13.5 cm 14mm, 13.5 cm 16mm,

Partsch
JU-7-147-02

Chisel

13.5 cm 2mm, 13.5 cm 3mm, 13.5 cm 4mm, 13.5 cm 5mm, 13.5 cm 6mm, 17 cm 2mm, 17 cm 3mm, 17 cm 4mm, 17 cm 5mm, 17 cm 6mm,

Partsch
JU-7-148-02

Gouge

13.5 cm 2mm, 13.5 cm 3mm, 17 cm 2mm, 17 cm 3mm,

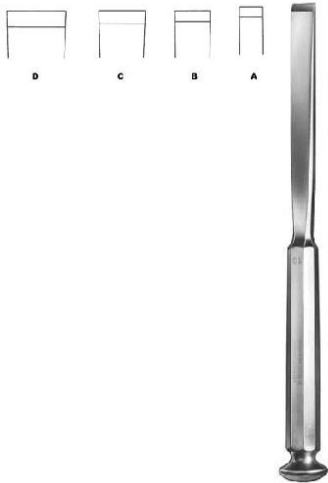
Stille
JU-7-149-10

Chisel

20 cm 10mm, 20 cm 15mm, 20 cm 20mm, 20 cm 25mm,

Stille
JU-7-150-10

Osteotome

20 cm 10mm, 20 cm 15mm, 20 cm 20mm, 20 cm 25mm,

Stille
JU-7-151-10

Gouges

20 cm 10mm, 20 cm 15mm, 20 cm 20mm, 20 cm 25mm,

Bone Surgery

Lambotte, Mini
JU-7-152-02

Osteotome

12.5 cm 2mm, 12.5 cm 3mm, 12.5 cm 4mm, 12.5 cm 6mm, 12.5 cm 8mm,

Lambotte
JU-7-153-15

Osteotome

24 cm 15mm, 24 cm 20mm, 24 cm 25mm, 24 cm 30mm,

Lambotte
JU-7-154-15

Osteotome

24 cm 15mm, 24 cm 20mm, 24 cm 25mm, 24 cm 30mm,

Smith-Petersen
JU-7-155-06

Osteotome

20.5 cm 6mm, 20.5 cm 9mm, 20.5 cm 13mm,

Smith-Petersen
JU-7-156-06

Osteotome

20.5 cm 6mm, 20.5 cm 9mm, 20.5 cm 13mm, 20.5 cm 16mm, 20.5 cm 19mm,

Smith-Petersen
JU-7-157-09

Gouge

20.5 cm 9mm, 20.5 cm 14mm, 20.5 cm 19mm, 20.5 cm 25mm,

Bone Surgery

Smith-Petersen
JU-7-158-09

Gouge

20.5 cm 9mm, 20.5 cm 14mm, 20.5 cm 19mm,

Hoke
JU-7-159-03

Osteotome

17 cm 3mm, 17 cm 5mm, 17 cm 6mm, 17 cm 8mm,

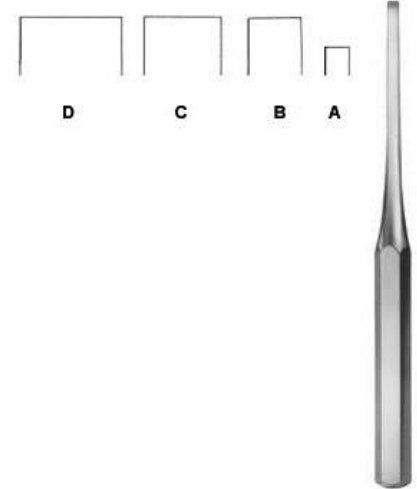
Hibbs
JU-7-160-06

Osteotome

24.5 cm 6mm, 24.5 cm 13mm, 24.5 cm 19mm,

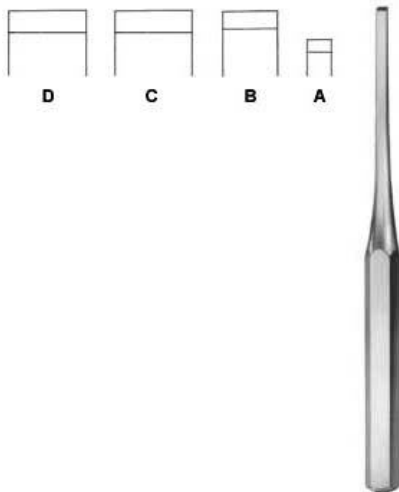
Hibbs
JU-7-161-06

Chisel

24.5 cm 6mm, 24.5 cm 19mm, 24.5 cm 13mm,

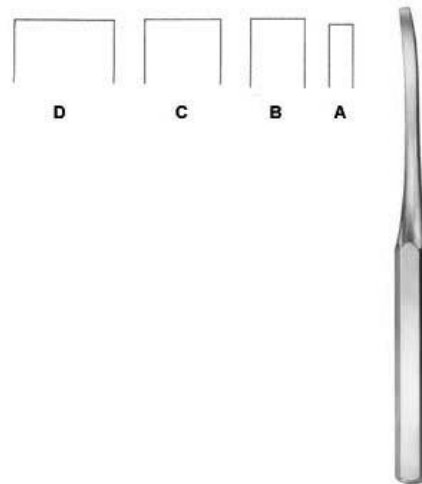
Hibbs
JU-7-162-06

Osteotome

24.5 cm 6mm, 24.5 cm 13mm, 24.5 cm 19mm,

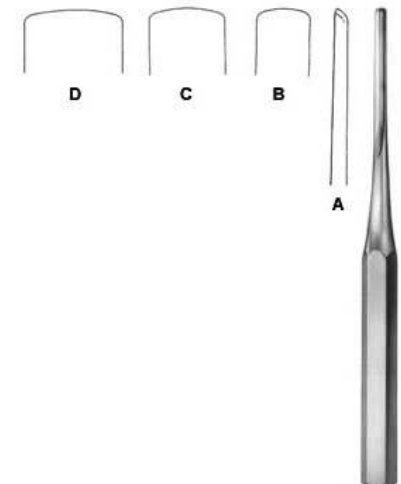
Hibbs
JU-7-163-06

Hibbs

24.5 cm 6mm, 24.5 cm 13mm, 24.5 cm 19mm,

Bone Surgery

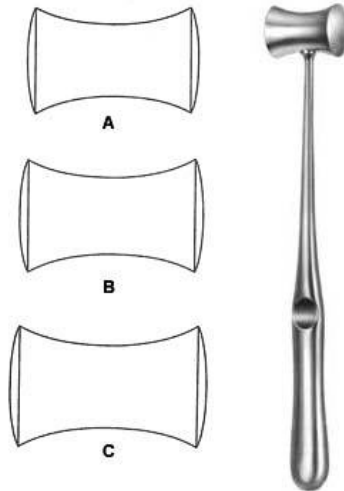

Hibbs
JU-7-164-06

Gouge
24.5 cm 6mm, 24.5 cm 13mm, 24.5 cm
19mm,

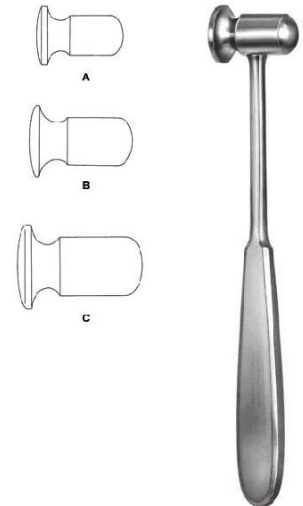

Williger
JU-7-165-01

Mallet
24 cm,



Doyen
JU-7-166-01

Mallet
20.5 cm, 21 cm, 21.5 cm,



Collin
JU-7-167-20

Mallet
20 cm,

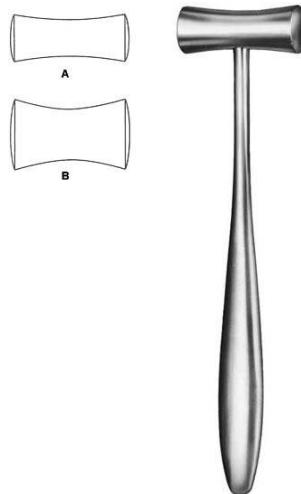

Lucae
JU-7-168-01

Mallet
19.5 cm,



Cottle
JU-7-169-19

Mallet
19 cm,

Bone Surgery



Williger
JU-7-170-01
 Mallet
 16.5 cm,



Mead
JU-7-171-17
 Mallet
 19 cm,

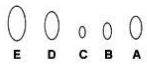

Partsch
JU-7-172-18
 Mallet
 19 cm,



Schede
JU-7-173-01
 Bone Curette Fig. 0 to 4
 17 cm,

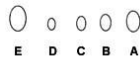

Volkman
JU-7-174-01
 Bone Curette
 17 cm Fig. 0, 17 cm Fig. 00, 17 cm Fig. 000, 17 cm Fig. 1, 17 cm Fig. 2, 17 cm Fig. 3, 17 cm Fig. 4,



Bruns
JU-7-175-01
 Bone Curette
 17 cm Fig. 0, 17 cm Fig. 00, 17 cm Fig. 000, 17 cm Fig. 1, 17 cm Fig. 2, 17 cm Fig. 3, 17 cm Fig. 4,

Bone Surgery

Spratt
JU-7-176-01

Bone Curette

17 cm Fig. 0, 17 cm Fig. 00, 17 cm Fig. 000, 17 cm Fig. 0000, 17 cm Fig. 1, 17 cm Fig. 2, 17 cm Fig. 3, 17 cm Fig. 4, 17 cm Fig. 5,

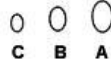

Bruns
JU-7-177-01

Bone Curette

23 cm Fig. 0, 23 cm Fig. 00, 23 cm Fig. 000, 23 cm Fig. 1, 23 cm Fig. 2, 23 cm Fig. 3,



Scoville
JU-7-178-25

Bone Curette

25 cm,

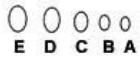

Simon
JU-7-179-01

Bone Curette

25 cm Fig. 1, 25 cm Fig. 2, 25 cm Fig. 3, 25 cm Fig. 4, 25 cm Fig. 5,



Modell USA
JU-7-180-01

Bone Curette

16 cm Fig. 1, 16 cm Fig. 2, 16 cm Fig. 3, 16 cm Fig. 4,



Modell USA
JU-7-181-01

Bone Curette

15.5 cm Fig. 1, 15.5 cm Fig. 2, 15.5 cm Fig. 3, 15.5 cm Fig. 4,

Bone Surgery

Modell USA
JU-7-182-01

Bone Curette

15.5 cm Fig. 1, 15.5 cm Fig. 2, 15.5 cm Fig. 3, 15.5 cm Fig. 4,

Halle
JU-7-183-01

Bone Curette

21 cm Fig. 1, 21 cm Fig. 2, 21 cm Fig. 3,

Volkman
JU-7-184-01

 Bone Curette, double-ended
 12.5 cm, 14.5 cm, 17 cm,

Volkman
JU-7-185-13

 Bone Curette, double-ended
 13 cm, 16 cm,

JU-7-186-21

 Bone Curette, double-ended
 21 cm,

Williger
JU-7-187-00

 Bone Curette, double-ended
 13.5 cm Fig. 00/0, 13.5 cm Fig. 0/1, 13.5 cm
 Fig. 1/2,

Bone Surgery



Hemingway
JU-7-189-11
Bone Curette, double-ended
18 cm,



Hemingway
JU-7-190-00
Bone Curette, double-ended
18.5 cm,

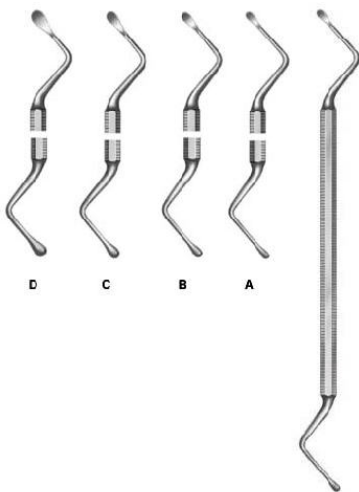

JU-7-191-01
Bone Curette, double-ended
17.5 cm,



Lucas
JU-7-192-11
Bone Curette, double-ended
18 cm,

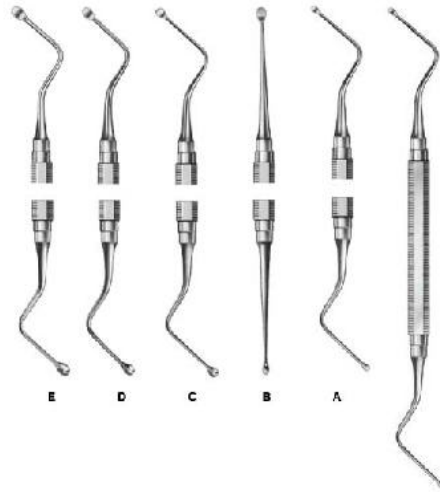

Miller-Colburn
JU-7-193-00
Bone Curette, double-ended
17 cm Fig. 0, 17 cm Fig. 1, 17 cm Fig. 2, 17
cm Fig. 3,

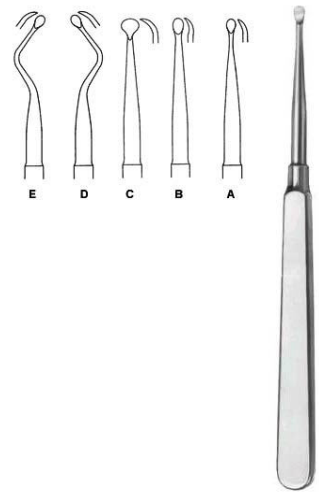

Molt
JU-7-194-01
Bone Curette
17 cm Fig. 1, 17 cm Fig. 2, 17 cm Fig. 3, 17
cm Fig. 4,

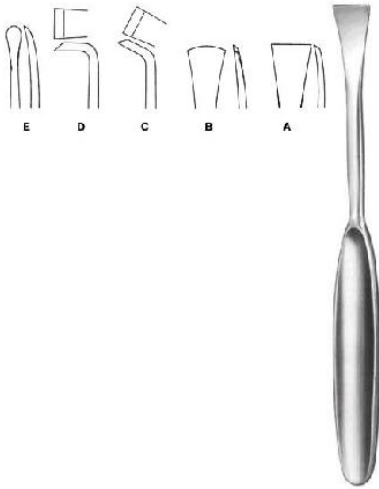
Bone Surgery

Martin-Langenbeck
JU-7-195-01
 Periosteal Elevator
 19 cm 16mm,



Langenbeck
JU-7-196-18
 Periosteal Elevator
 18.5 cm,



Langenbeck
JU-7-197-19
 Periosteal Elevator
 19.5 cm,



JU-7-198-05
 Periosteal Elevator
 16 cm 5mm, 16 cm 6mm, 16 cm 7mm,



Sedillot
JU-7-199-21
 Periosteal Elevator
 22 cm 15mm,



Williger
JU-7-200-13
 Periosteal Elevator
 12.5 cm 5mm,

Bone Surgery

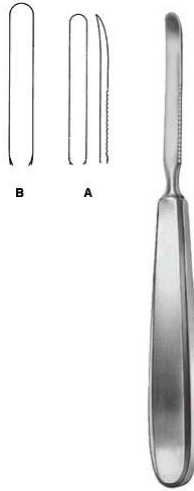

Kahre-Williger
JU-7-201-04
 Periosteal Elevator
 4 mm, 5 mm, 7 mm,



JU-7-202-06
 Periosteal Elevator
 17 cm 6 mm, 17 cm 8 mm,

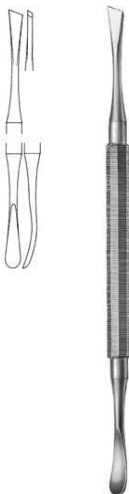

Doyen
JU-7-203-17
 Rib Raspatory
 17.5 cm,



West
JU-7-204-19
 Periosteal Elevator, double-ended
 18.5 cm,



Ohl
JU-7-205-17
 Periosteal Elevator, double-ended
 17.5 cm,



Semb
JU-7-206-01
 Periosteal Elevator
 18.5 cm Fig. 1, 21.5 cm Fig. 2,

Bone Surgery

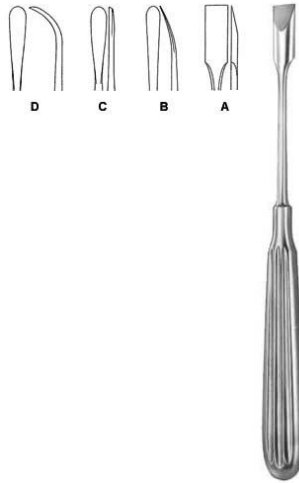

JU-7-207-22
Bone File
22 cm,

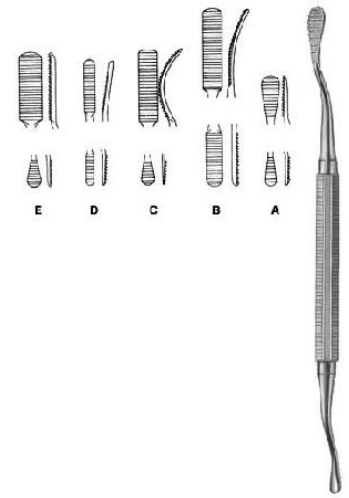

Adson
JU-7-208-17
Elevator
17 cm, 17.5 cm,

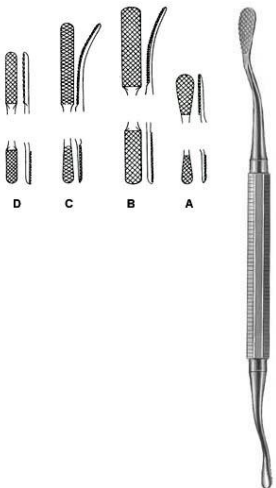

Miller-Colburn
JU-7-209-01
Bone File
18 cm Fig. 1, 18 cm Fig. 2, 18 cm Fig. 3, 18 cm Fig. 4, 18 cm Fig. 5,



Miller-Colburn
JU-7-210-01
Bone File
18 cm Fig. 1, 18 cm Fig. 2, 18 cm Fig. 3, 18 cm Fig. 4,



Langenbeck
JU-7-211-20
Elevator
19.5 cm 8 mm, 19.5 cm 10 mm,

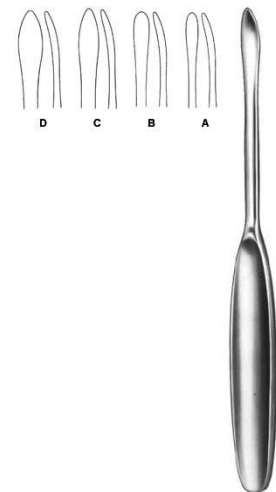

Martin-Langenbeck
JU-7-212-01
Elevator
17 cm 5 mm, 17 cm 7 mm, 17 cm 8 mm,

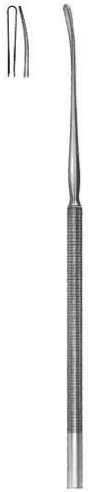
Bone Surgery

Vickers
JU-7-213-17
 Elevator
 17 cm,



Vickers
JU-7-214-17
 Dissector
 17 cm,



Williger
JU-7-215-17
 Elevator
 16 cm 5,5 mm,



Williger
JU-7-216-16
 Elevator
 16 cm 5,5 mm,



Mead
JU-7-217-17
 Mallet
 19 cm,



JU-7-218-18
 Periosteal Elevator

Bone Surgery

Hohmann
JU-7-219-43
 Bone Lever
 23.5 cm,



Lempert
JU-7-220-19
 Bone Rongeur
 19 cm,



Luer
JU-7-221-17
 Bone Rongeur
 18.5 cm, 18 cm,



Zaufal-Jansen
JU-7-222-18
 Bone Rongeur
 18 cm,

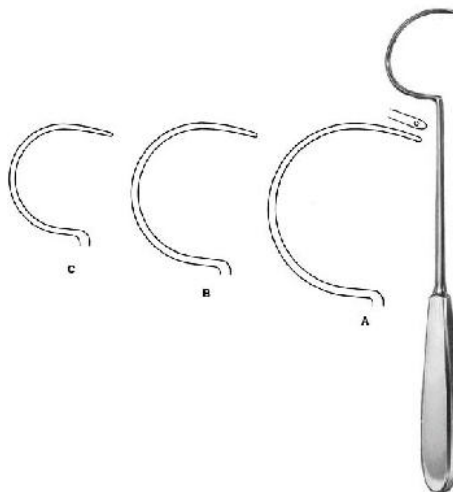

Demel
JU-7-124-01
 Wire Guide
 31 cm Fig. 1, 29 cm Fig. 2, 28 cm Fig. 3,



CARROL
JU-7-124-02
 CARROL
 11 cm,

Bone Surgery

BRAND
JU-7-124-03
BRAND



BRAND
JU-7-124-04
BRAND
 15 cm,



BRAND
JU-7-124-05
BRAND
 19 cm,



BRAND
JU-7-124-06
BRAND
 25 cm,



KLEINERT-KUTZ
JU-7-124-07
KLEINERT-KUTZ
 20 cm,

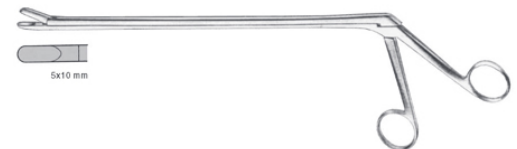

ZEMENT
JU-7-124-08
ZEMENT
 25 cm / 5x10 mm,

Micro Surgery



straight
JU-20-185-01
straight



straight
JU-20-185-02
straight



straight
JU-20-185-03
straight



curved up
JU-20-185-04
curved up



curved up
JU-20-185-05
curved up



curved up
JU-20-185-06
curved up

Micro Surgery

curved to right
JU-20-185-07
 curved to right



curved to right
JU-20-185-08
 curved to right



curved to left
JU-20-185-09
 curved to left



curved to left
JU-20-185-10
 curved to left



straight
JU-20-185-11
 straight
 1,0 mm Ø, 1,5 mm Ø, 2,0 mm Ø, 2,5 mm Ø,



straight
JU-20-185-12
 straight

Micro Surgery

curved up
JU-20-185-13
 curved up

1,0 mm Ø, 1,5 mm Ø, 2,0 mm Ø, 2,5 mm Ø,



curved up
JU-20-185-14
 curved up



curved to right
JU-20-185-15
 curved to right

1,0 mm Ø, 1,5 mm Ø, 2,0 mm Ø, 2,5 mm Ø,



curved to right
JU-20-185-16
 curved to right



curved to left
JU-20-185-17
 curved to left

1,0 mm Ø, 1,5 mm Ø, 2,0 mm Ø, 2,5 mm Ø,

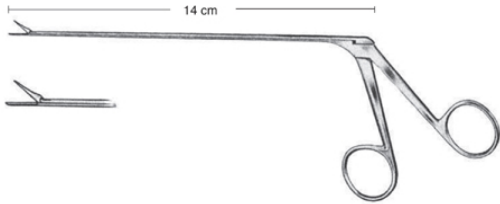

curved to left
JU-20-185-18
 curved to left

Micro Surgery

micro-scissors
JU-20-185-19
 micro-scissors

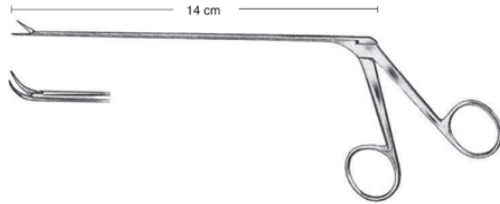

micro-scissors
JU-20-185-20
 micro-scissors

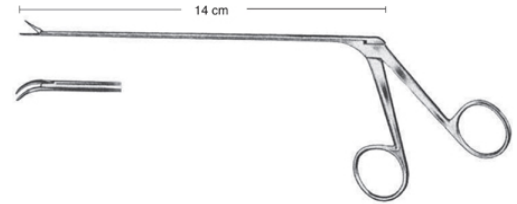

micro-scissors
JU-20-185-21
 micro-scissors

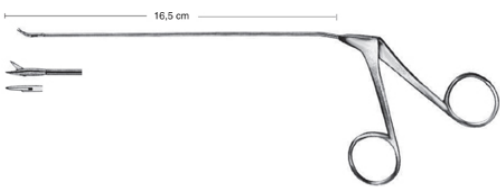

micro-scissors
JU-20-185-22
 micro-scissors



micro-scissors
JU-20-185-23
 micro-scissors

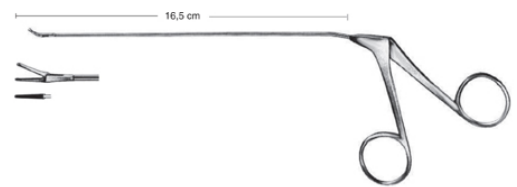

Micro forceps
JU-20-185-24
 Micro forceps



JIMY

SURGICAL INSTRUMENTS

Micro Surgery

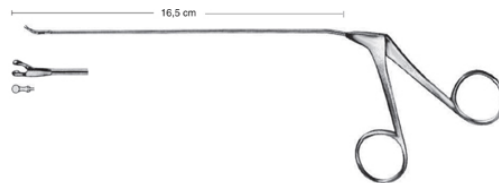

Micro forceps

JU-20-185-25

Micro forceps
2,5 mm,

Otology Promed



LITTAUER
JU-20-186-01
 LITTAUER
 12 cm,



HARTMANN
JU-20-186-02
 HARTMANN
 12 cm,

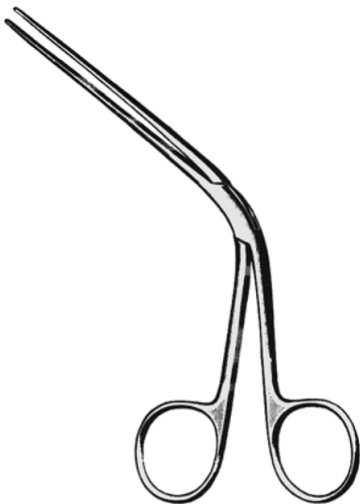

HARTMANN
JU-20-186-03
 HARTMANN
 14 cm,



TILLEY
JU-20-186-04
 TILLEY
 14 cm,



QUIRE
JU-20-186-05
 QUIRE
 10 cm,

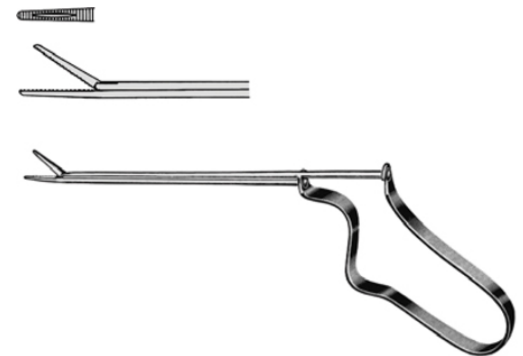

BUCK
JU-20-186-06
 BUCK
 11 cm,



STRUEMPEL
JU-20-186-07
 STRUEMPEL



HARTMANN
JU-20-186-08
 HARTMANN
 8.5 cm, 14.0 cm, 16.5 cm,

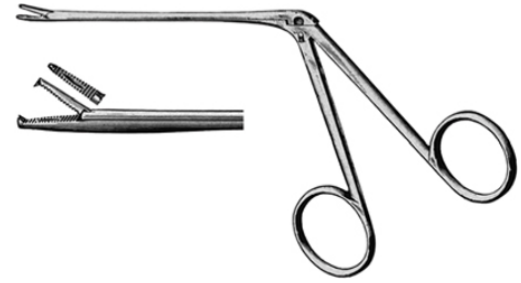

HARTMANN
JU-20-186-09
 HARTMANN
 8.5 cm 1x2, 14.0 cm 1x2, 16.5 cm 1x2,

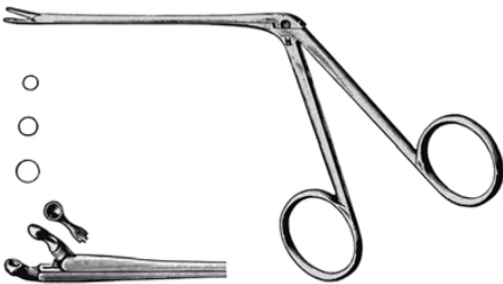

HERZFELD
JU-20-186-10
 HERZFELD
 8.5 cm, 2.0 mm ø, 2.0 mm ø, 2.5 mm ø, 3.0 mm ø,

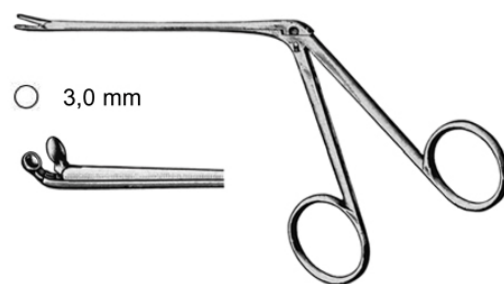

HERZFELD
JU-20-186-11
 HERZFELD
 8.5 , 3,0 mm Ø,

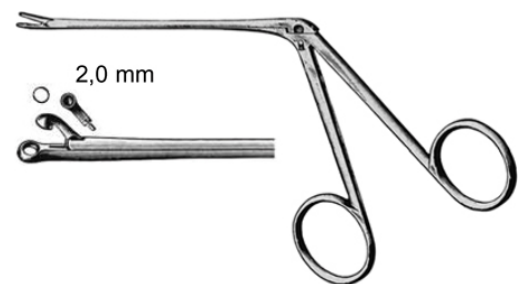

HOFFMANN
JU-20-186-12
 HOFFMANN
 8,5 cm, 2 mm,

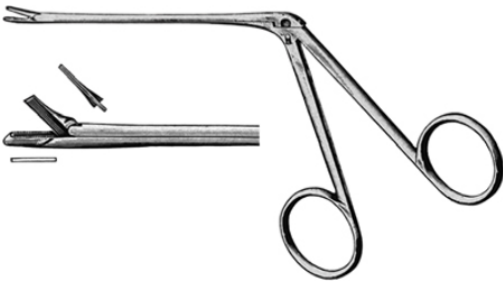

HARTMANN
JU-20-186-13
 HARTMANN
 8.5 cm,

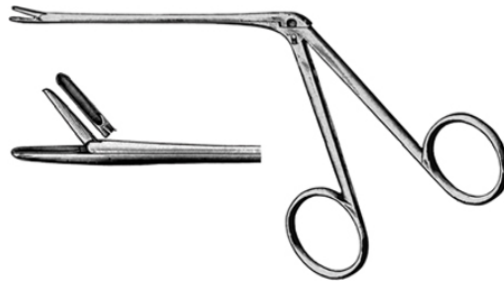

HARTMANN
JU-20-186-14
 HARTMANN
 8.5 cm,

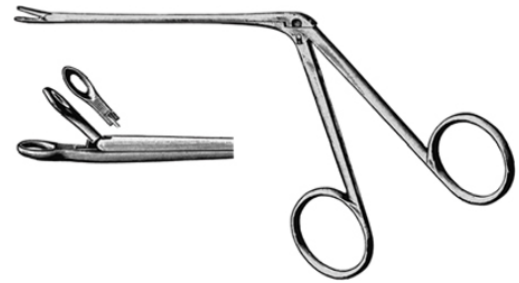

STRUEMPEL
JU-20-186-15
 STRUEMPEL
 8.5 cm,

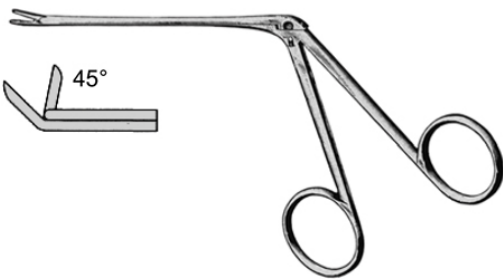

STRUEMPEL
JU-20-186-16
 STRUEMPEL
 8.5 , 2,5 mm,

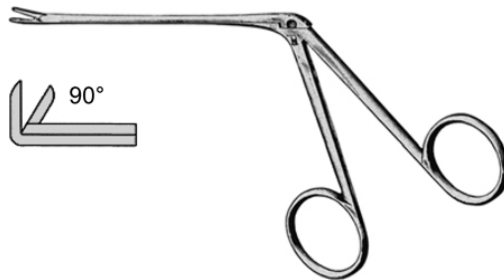

STRUEMPEL
JU-20-186-17
 STRUEMPEL
 8.5 , 2,5 mm,

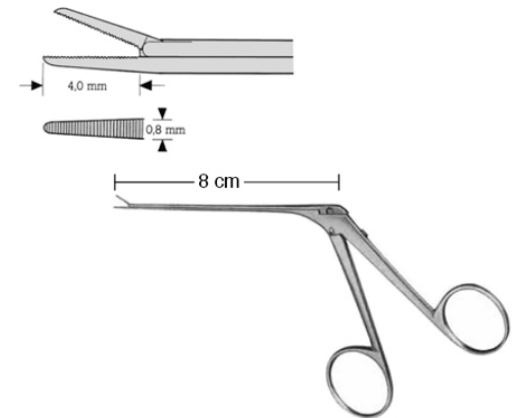

HARTMANN-MIKRO
JU-20-186-18
 Curved up
 Left
 Right
 Curved

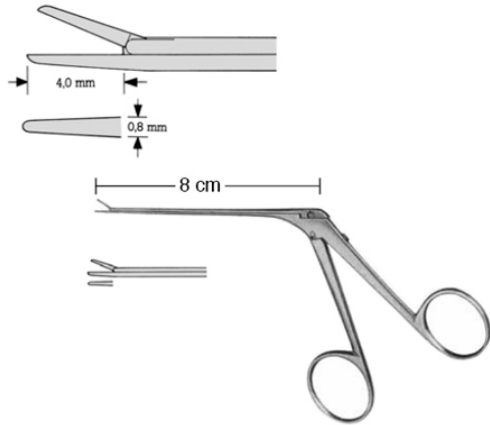

HARTMANN-MIKRO
JU-20-186-19
 glatt / smooth / lisse
 4x0,8,

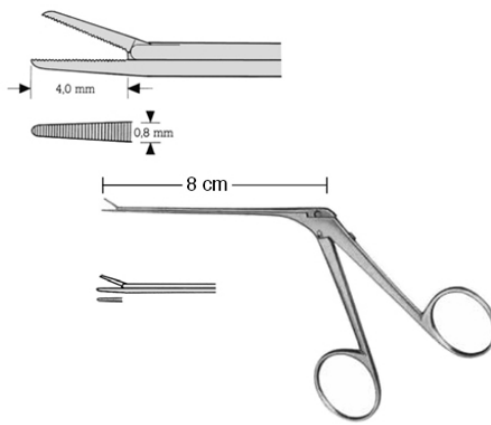

HARTMANN-MIKRO
JU-20-186-20
 gezahnt / serrated /
 4x0,8,

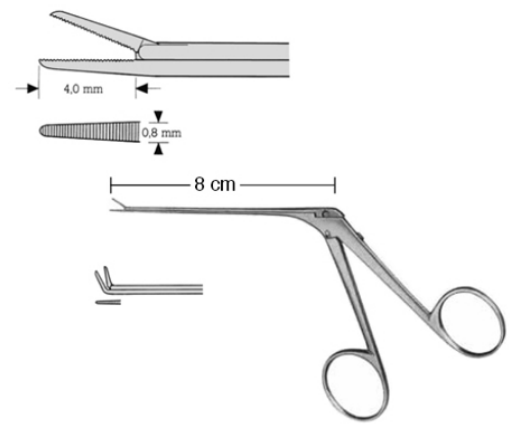

HARTMANN-MIKRO
JU-20-186-21
 aufgebogen / curved up
 4x0,8,

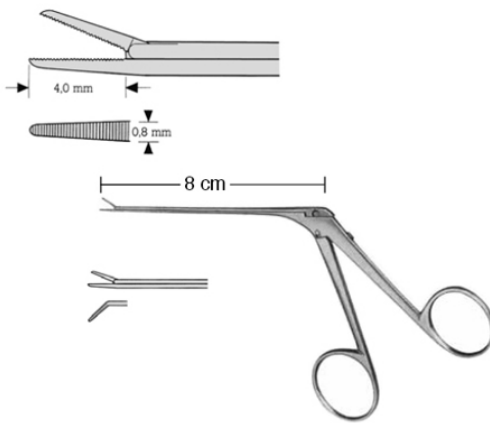

HARTMANN-MIKRO
JU-20-186-22
 links / left

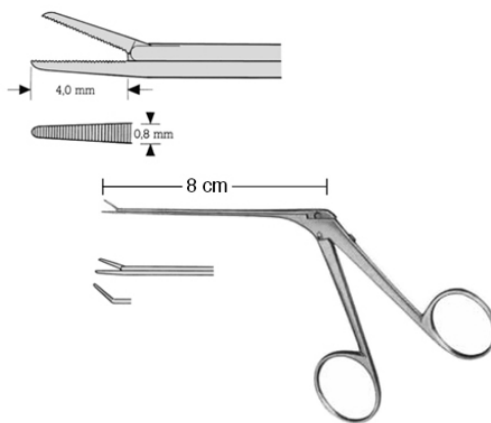

HARTMANN-MIKRO
JU-20-186-23
 rechts / right

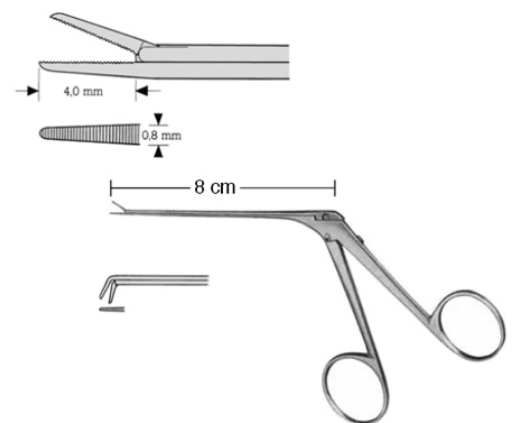

HARTMANN-MIKRO
JU-20-186-24
 curved downwards

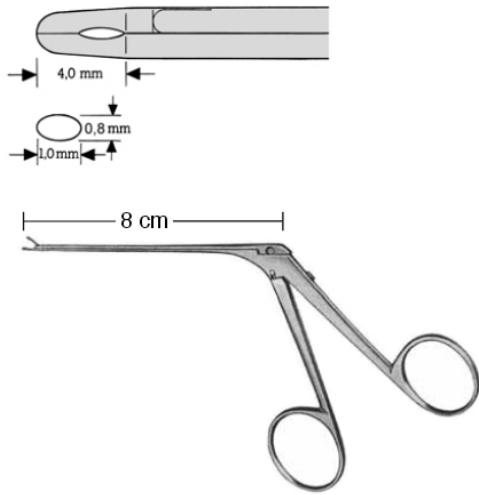
Otology Promed

WULLSTEIN
JU-20-186-25
WULLSTEIN

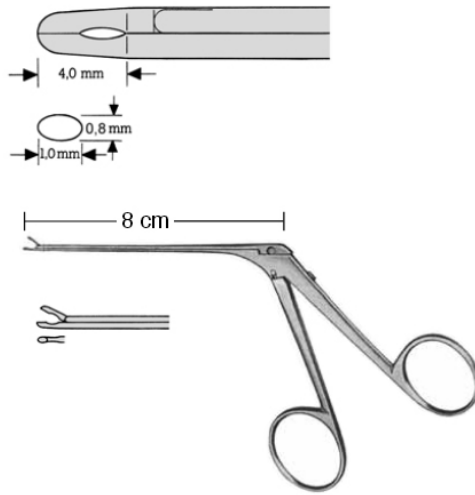

WULLSTEIN
JU-20-186-26
straight

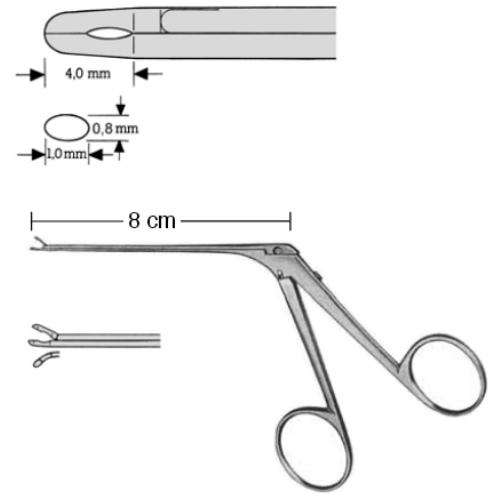

WULLSTEIN
JU-20-186-27
Left

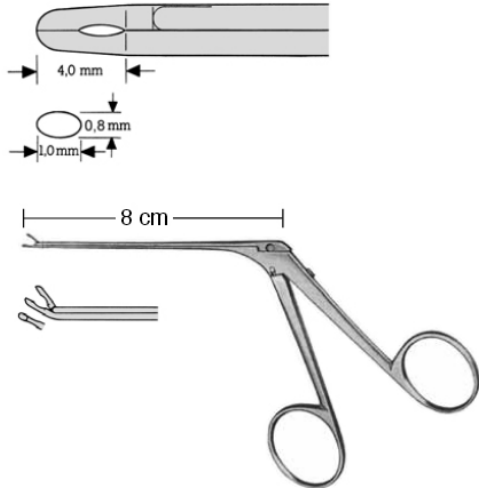

WULLSTEIN
JU-20-186-28
Curved up

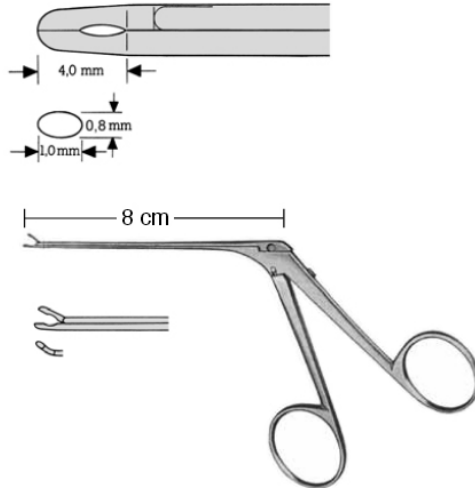

WULLSTEIN
JU-20-186-29
right

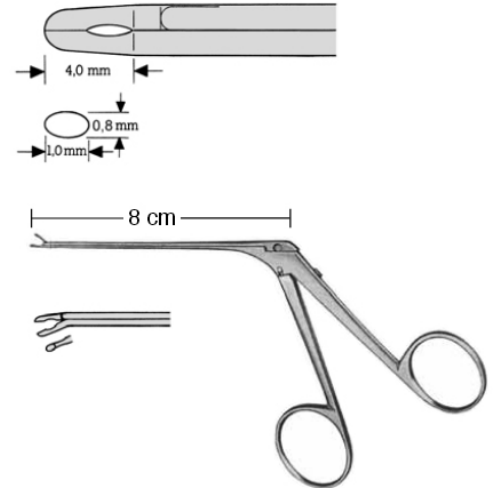

WULLSTEIN
JU-20-186-30
curved downwards

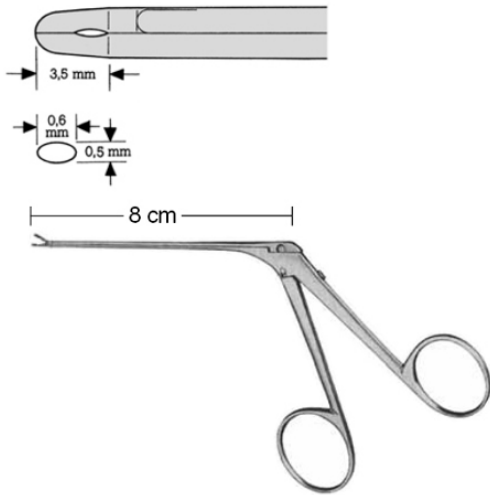
Otology Promed

HARTMANN WULLSTEIN
JU-20-186-31
 HARTMANN WULLSTEIN

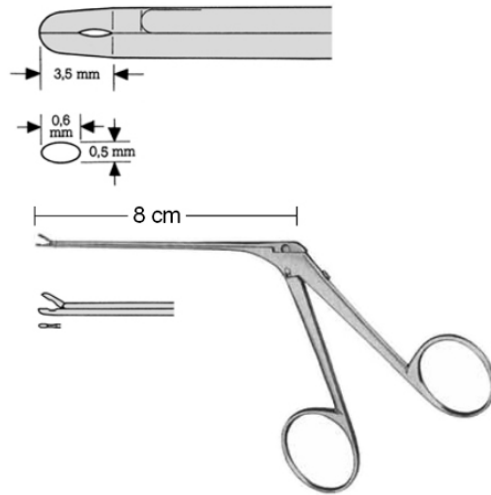

HARTMANN WULLSTEIN
JU-20-186-32
 straight

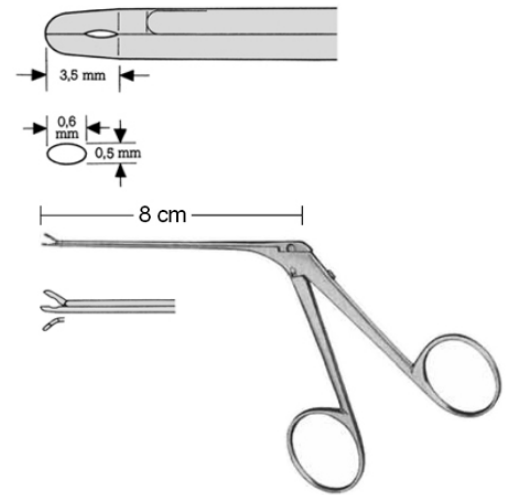

HARTMANN WULLSTEIN
JU-20-186-33
 left

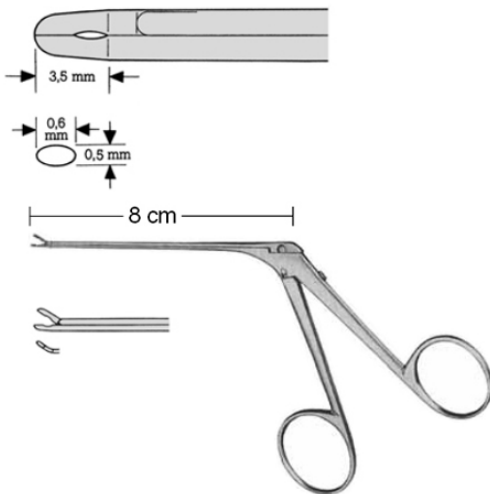

HARTMANN WULLSTEIN
JU-20-186-34
 right

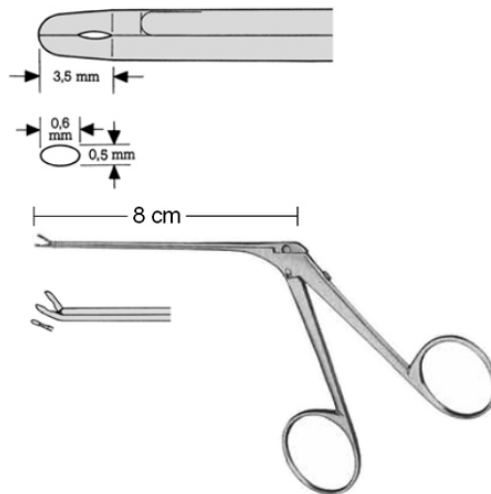

HARTMANN WULLSTEIN
JU-20-186-35
 curved up

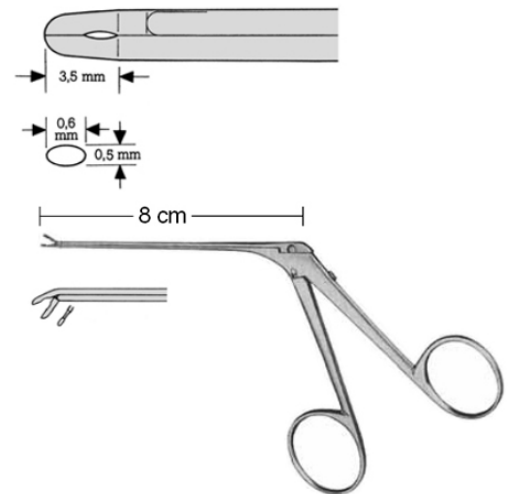

HARTMANN WULLSTEIN
JU-20-186-36
 curved downwards

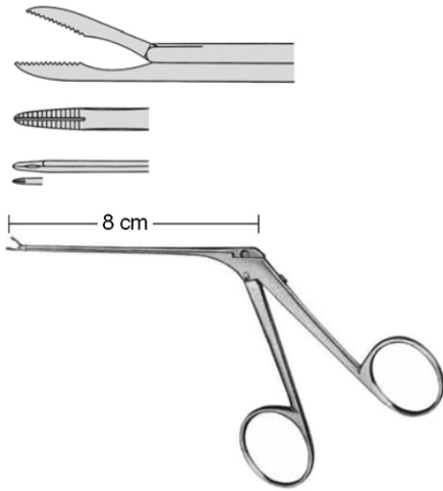
Otology Promed

GREVEN
JU-20-186-37
 GREVEN



WULLSTEIN
JU-20-186-38
 WULLSTEIN
 1 mm Ø, 2 mm Ø,

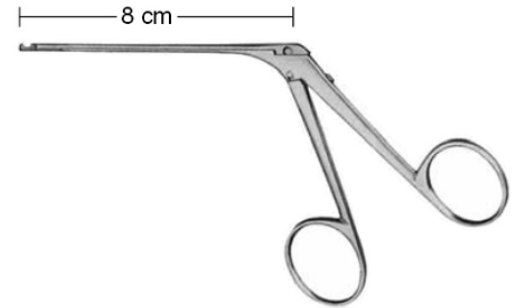

DIETER
JU-20-186-39
 DIETER

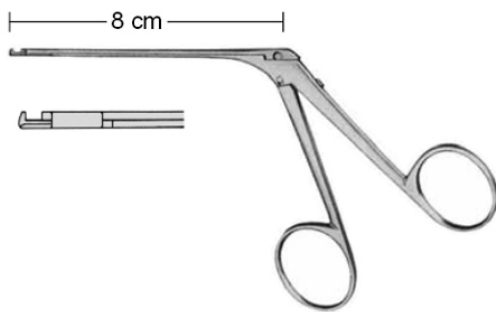

DIETER
JU-20-186-40
 up-cutting

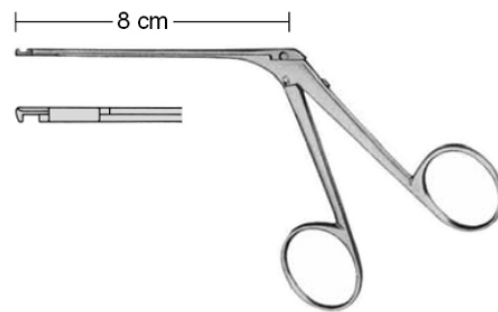

DIETER
JU-20-186-41
 down-cutting

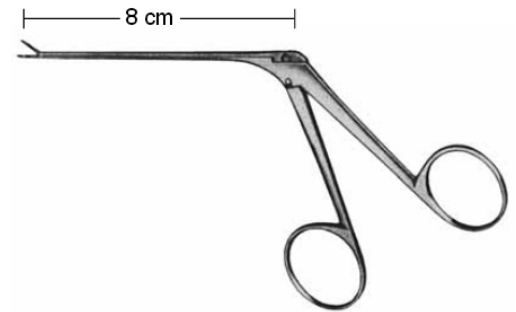

FULLER
JU-20-186-42
 Introducing Forceps for Teflon prosthesis

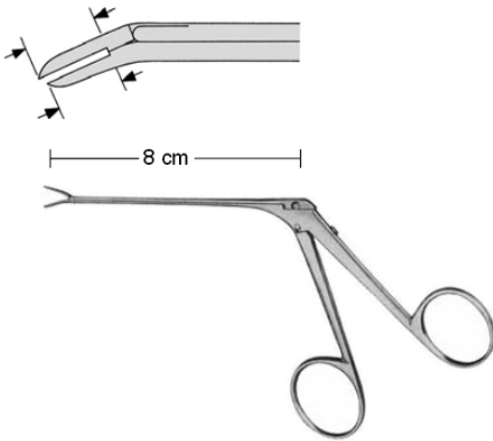

McGEE
JU-20-186-43
 Wire Bending Forceps

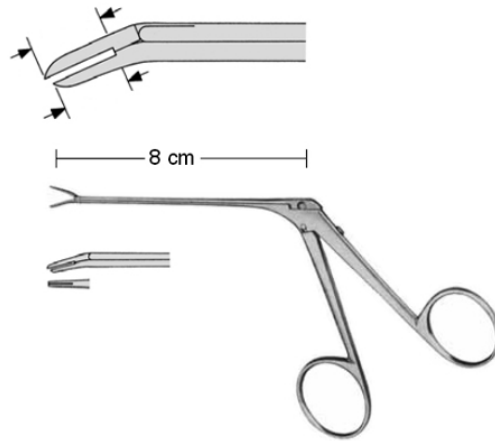

McGEE
JU-20-186-44
 Wire Bending Forceps
 0,8 x 3,5 mm,

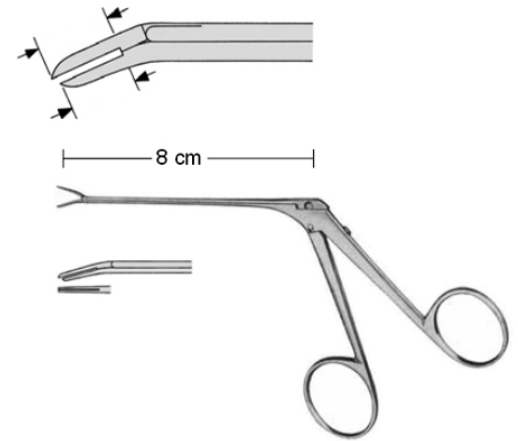

McGEE
JU-20-186-45
 Wire Bending Forceps
 0,8 x 6 mm,

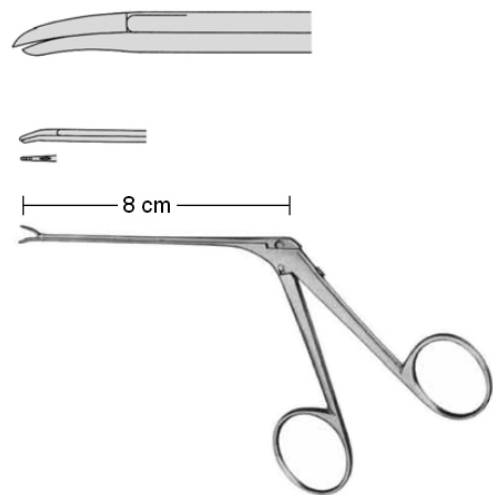

SCHUKNECHT
JU-20-186-46
 SCHUKNECHT

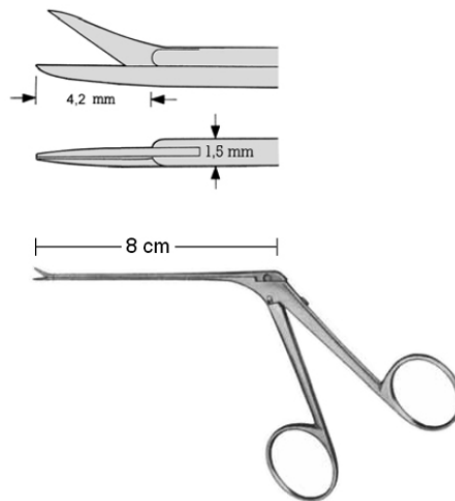

BELLUCCI
JU-20-186-47
 BELLUCCI

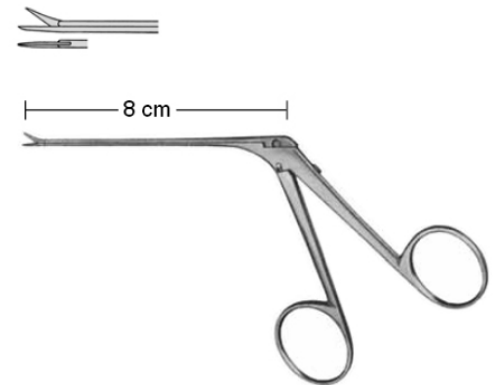

BELLUCCI
JU-20-186-48
 straight

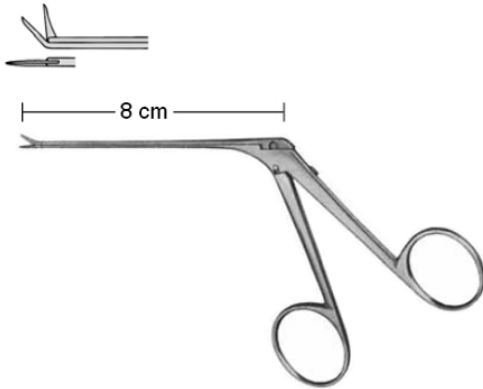
Otology Promed

BELLUCCI
JU-20-186-49
 curved up

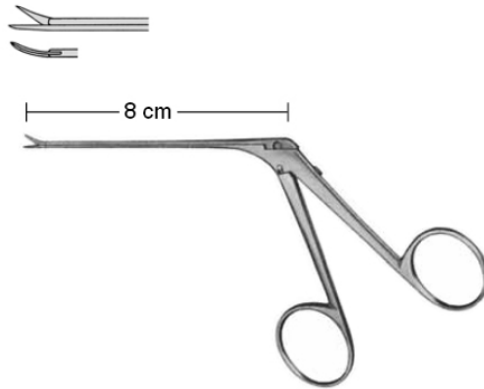

BELLUCCI
JU-20-186-50
 right

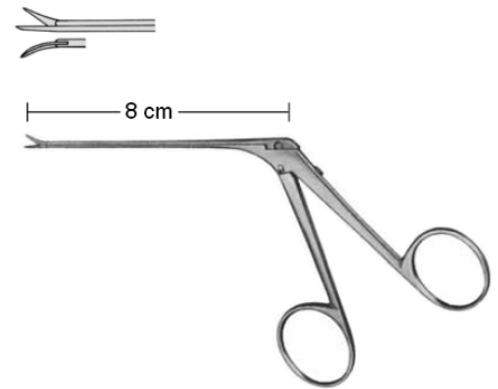

BELLUCCI
JU-20-186-51
 left

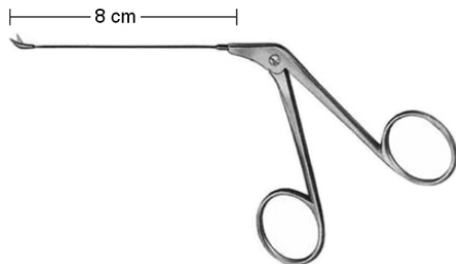
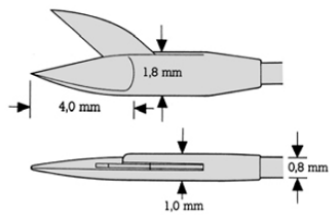

WULLSTEIN
JU-20-186-52
 WULLSTEIN

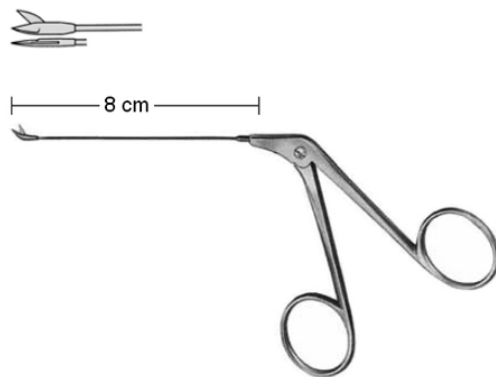

WULLSTEIN
JU-20-186-53
 straight

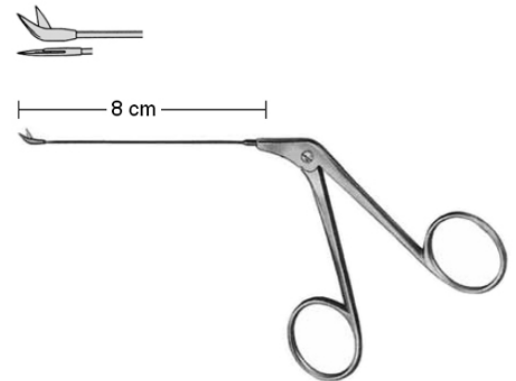

WULLSTEIN
JU-20-186-54
 curved up

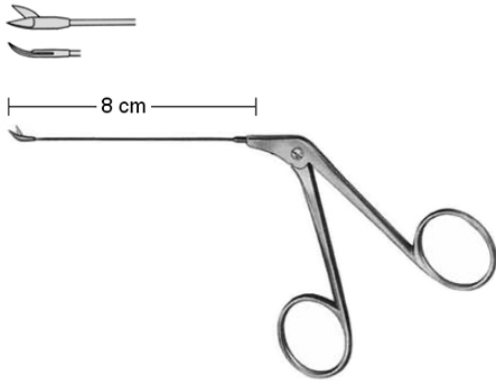
Otology Promed

WULLSTEIN
JU-20-186-55
 right

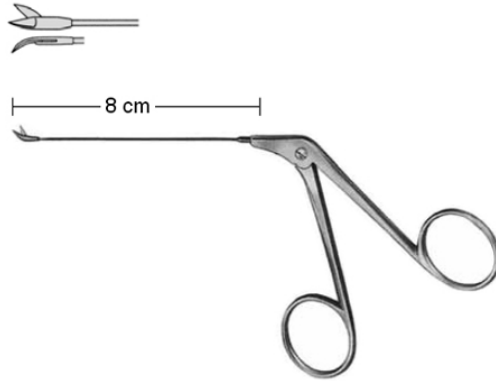

WULLSTEIN
JU-20-186-56
 left

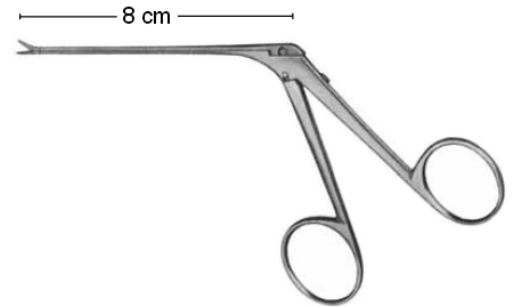

SHEA-BELLUCC
JU-20-186-57
 SHEA-BELLUCC
 7 mm,

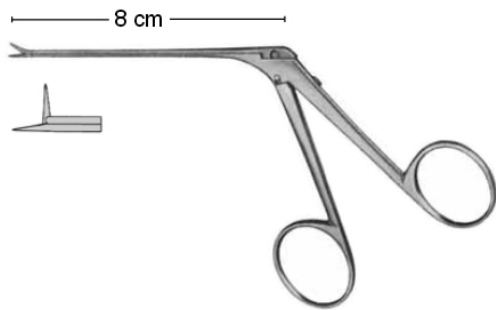

SHEA-BELLUCC
JU-20-186-58
 straight

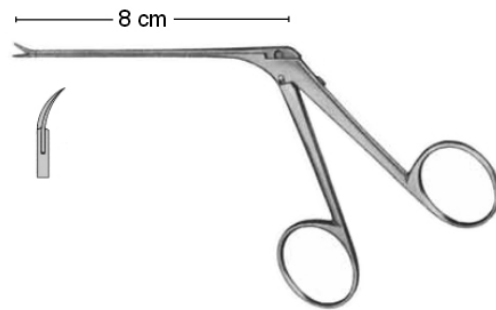

SHEA-BELLUCC
JU-20-186-59
 curved up

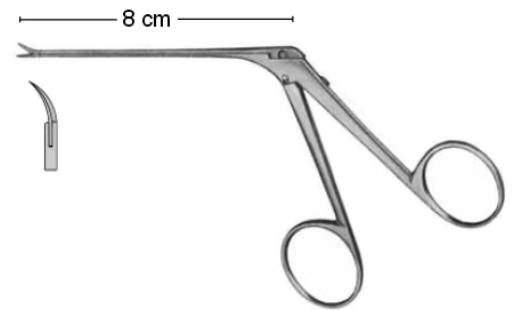

SHEA-BELLUCC
JU-20-186-60
 right



JIMY

SURGICAL INSTRUMENTS

Otology Promed

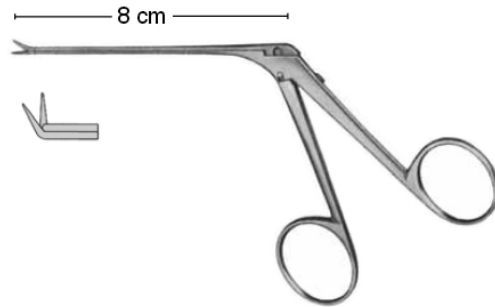

SHEA-BELLUCC
JU-20-186-61
left

Laryngo



JURASZ
JU-21-187-01
 JURASZ
 23 cm,

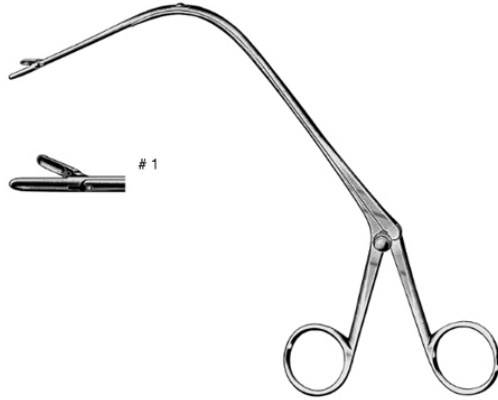

JURASZ
JU-21-187-02
 opening right

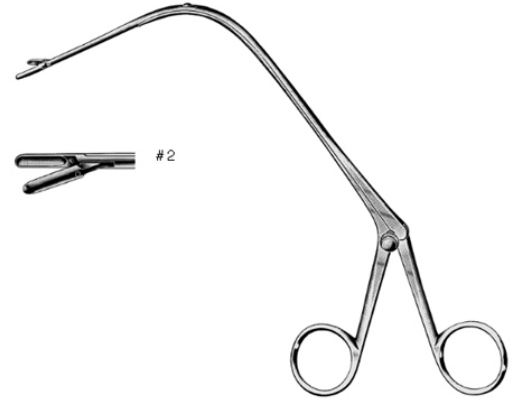

JURASZ
JU-21-187-03
 opening left

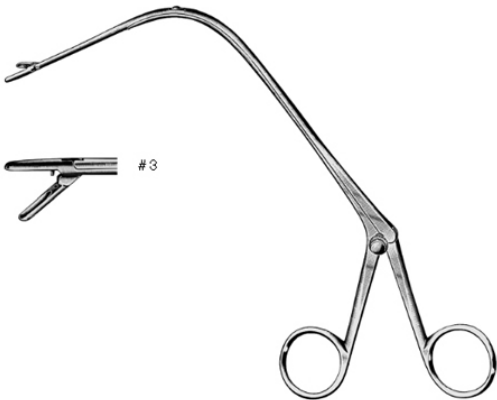

JURASZ
JU-21-187-04
 opening downward

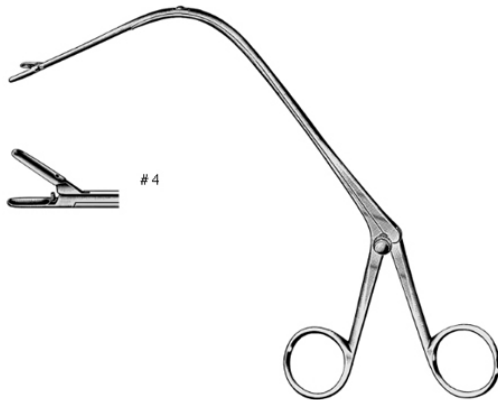

JURASZ
JU-21-187-05
 opening upward

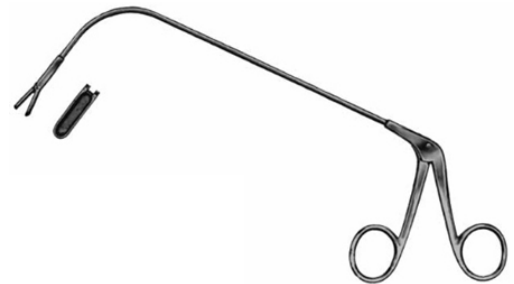

FRAENKEL
JU-21-187-06
 both jaws articulated

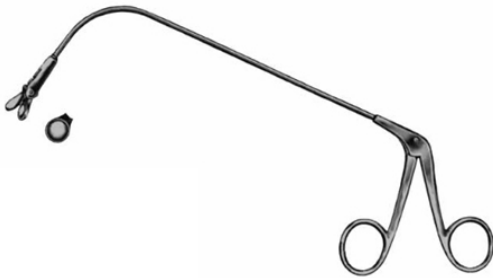
Laryngo

LANGE
JU-21-187-07
 both jaws articulated



HUBER
JU-21-187-08
 Universal Handle for extension tubes
 35.0220 - 35.0320



BRUENINGS
JU-21-187-09
 Extension Tubes
 20 cm, 30 cm, 40 cm, 50 cm, 60 cm,



BRUENINGS
JU-21-187-10
 BRUENINGS
 20 cm,

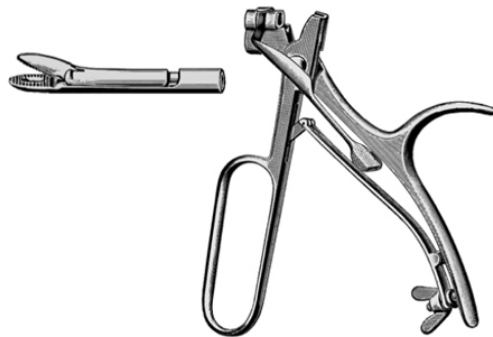

FRAENKEL
JU-21-187-11
 EXCHANGEABLE TIPS

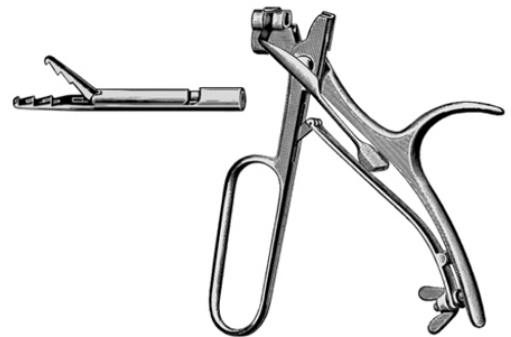

SEIFFERT
JU-21-187-12
 EXCHANGEABLE TIPS

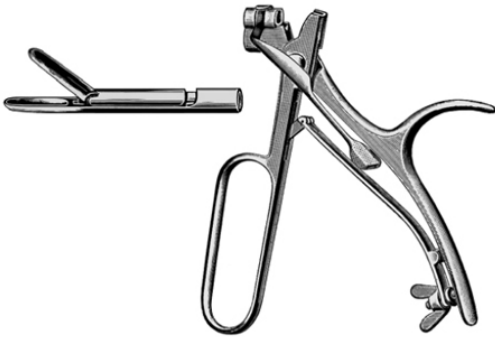

FRAENKEL
JU-21-187-13
 EXCHANGEABLE TIPS

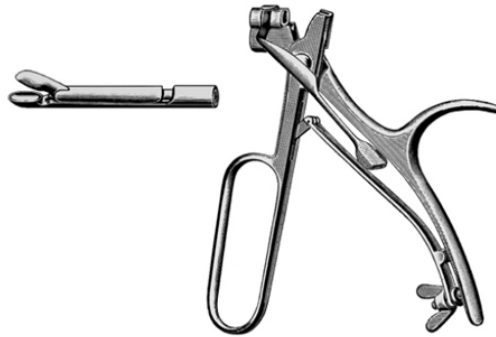

LANGE
JU-21-187-14
 EXCHANGEABLE TIPS

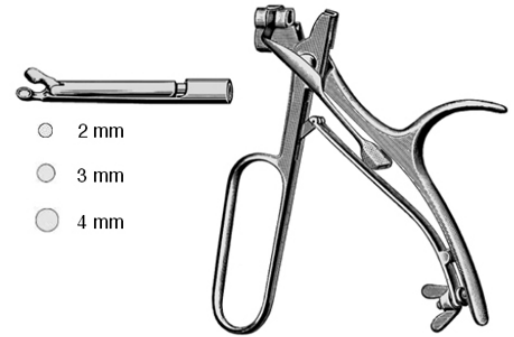

BRUENINGS
JU-21-187-15
 EXCHANGEABLE TIPS
 2 mm, 3 mm, 4 mm,

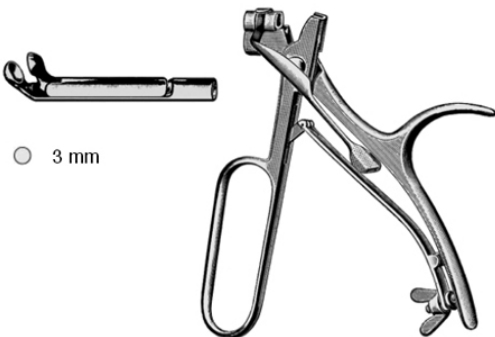

BRUENINGS
JU-21-187-16
 EXCHANGEABLE TIPS
 3 mm,

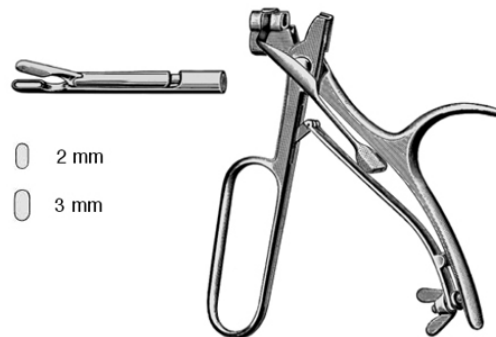

BRUENINGS
JU-21-187-17
 EXCHANGEABLE TIPS
 2 mm, 3 mm,

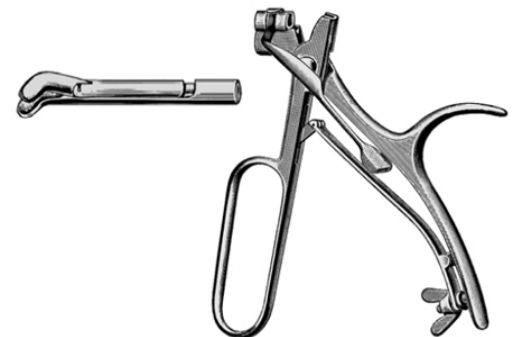

SCHEINMANN
JU-21-187-18
 EXCHANGEABLE TIPS

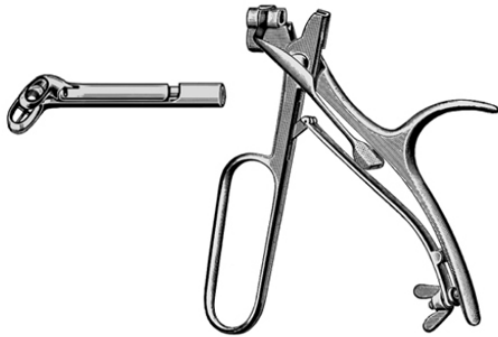
Laryngo

SCHEINMANN
JU-21-187-19
 EXCHANGEABLE TIPS

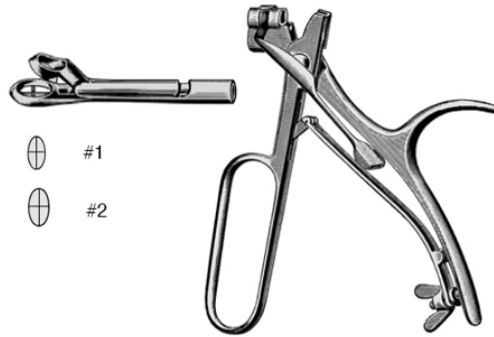

KRAUSE
JU-21-187-20
 EXCHANGEABLE TIPS

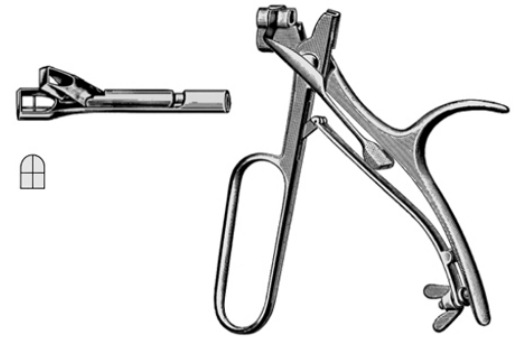

KRAUSE
JU-21-187-21
 EXCHANGEABLE TIPS

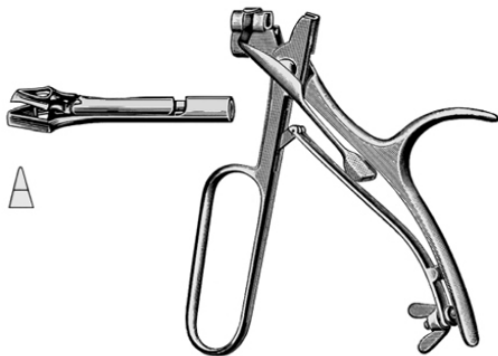

SCHUMACHER
JU-21-187-22
 EXCHANGEABLE TIPS

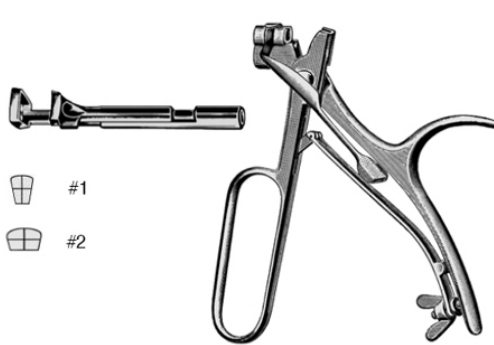

CORDES
JU-21-187-23
 EXCHANGEABLE TIPS

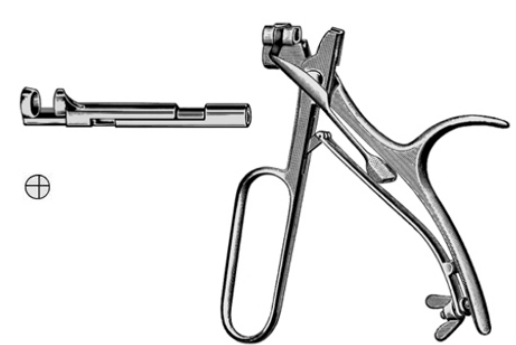

CORDES
JU-21-187-24
 EXCHANGEABLE TIPS

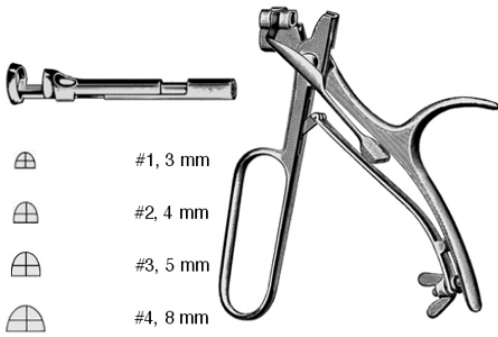
Laryngo

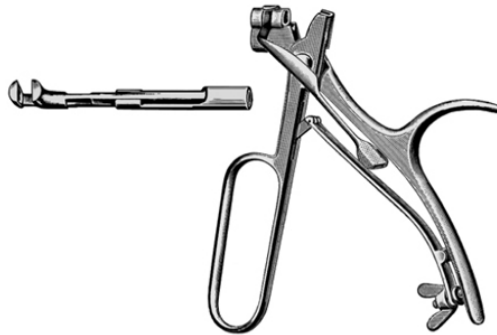
CORDES
JU-21-187-25

 EXCHANGEABLE TIPS
 3 mm, 4 mm, 5 mm, 4, 8 mm,

ROSENBERG
JU-21-187-26

EXCHANGEABLE TIPS

CHEVALIER-JACKSON
JU-21-187-27

CHEVALIER-JACKSON

CHEVALIER-JACKSON
JU-21-187-28

 CHEVALIER-JACKSON
 30 cm, 40 cm, 50 cm, 60 cm,

CHEVALIER-JACKSON
JU-21-187-29

 CHEVALIER-JACKSON
 30 cm, 40 cm, 50 cm, 60 cm,

CHEVALIER-JACKSON
JU-21-187-30

 CHEVALIER-JACKSON
 30 cm, 40 cm, 50 cm, 60 cm,

Laryngo

CHEVALIER-JACKSON
JU-21-187-31
 CHEVALIER-JACKSON
 30 cm,40 cm,50 cm,60 cm,



CHEVALIER-JACKSON
JU-21-187-32
 CHEVALIER-JACKSON
 30 cm,40 cm,50 cm,60 cm,



CHEVALIER-JACKSON
JU-21-187-33
 CHEVALIER-JACKSON
 30 cm,40 cm,50 cm,60 cm,



CHEVALIER-JACKSON
JU-21-187-34
 CHEVALIER-JACKSON
 30 cm,40 cm,50 cm,60 cm,



LARYNGO-Bronchoscopy
JU-21-187-35
 LARYNGO-Bronchoscopy
 Shaft Ø 2,5 mm,



LARYNGO-Bronchoscopy
JU-21-187-36
 LARYNGO-Bronchoscopy
 40 cm,50 cm,60 cm,

Laryngo



LARYNGO-Bronchoscopy
JU-21-187-37
 LARYNGO-Bronchoscopy
 40 cm,50 cm,60 cm,



LARYNGO-Bronchoscopy
JU-21-187-38
 LARYNGO-Bronchoscopy
 40 cm,50 cm,60 cm,



LARYNGO-Bronchoscopy
JU-21-187-39
 LARYNGO-Bronchoscopy
 40 cm,50 cm,60 cm,

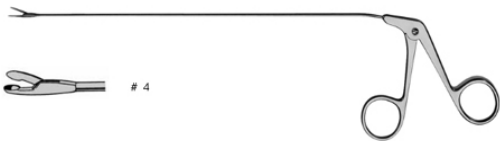

LARYNGO-Bronchoscopy
JU-21-187-40
 LARYNGO-Bronchoscopy
 40 cm,50 cm,60 cm,

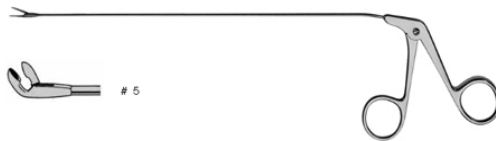

LARYNGO-Bronchoscopy
JU-21-187-41
 LARYNGO-Bronchoscopy
 40 cm,50 cm,60 cm,

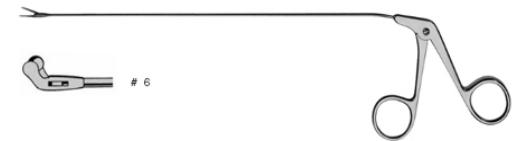

LARYNGO-Bronchoscopy
JU-21-187-42
 LARYNGO-Bronchoscopy
 40 cm,50 cm,60 cm,

Laryngo

LARYNGO-Bronchoscopy
JU-21-187-43
 LARYNGO-Bronchoscopy
 40 cm, 50 cm, 60 cm,



LARYNGO-Bronchoscopy
JU-21-187-44
 LARYNGO-Bronchoscopy
 40 cm, 50 cm, 60 cm,



LARYNGO-Bronchoscopy
JU-21-187-45
 LARYNGO-Bronchoscopy
 40 cm, 50 cm, 60 cm,



LARYNGO-Bronchoscopy
JU-21-187-46
 LARYNGO-Bronchoscopy
 40 cm, 50 cm, 60 cm,



LARYNGO-Bronchoscopy
JU-21-187-47
 LARYNGO-Bronchoscopy
 40 cm, 50 cm, 60 cm,

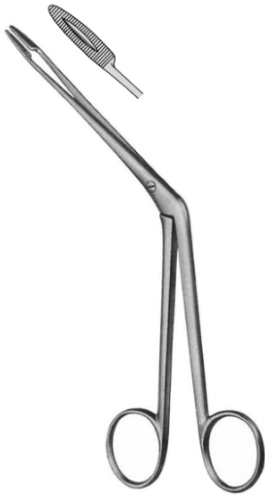

LARYNGO-Bronchoscopy
JU-21-187-48
 LARYNGO-Bronchoscopy
 40 cm, 50 cm, 60 cm,

Rhinology

HARTMANN
JU-22-188-01
 HARTMANN
 20 cm,



HARTMANN
JU-22-188-02
 HARTMANN
 16 cm,



LITTAUER
JU-22-188-03
 LITTAUER
 18 cm,

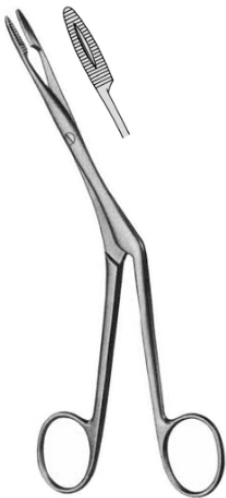

KNIGHT
JU-22-188-04
 KNIGHT
 18 cm,

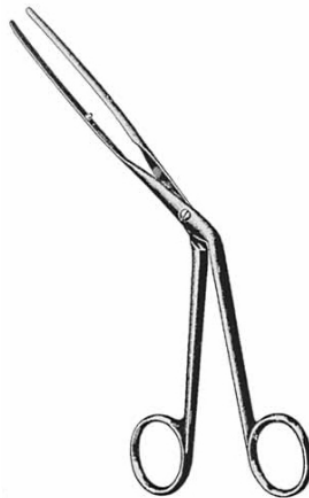

LUBET-BARBON
JU-22-188-05
 LUBET-BARBON
 20 cm,

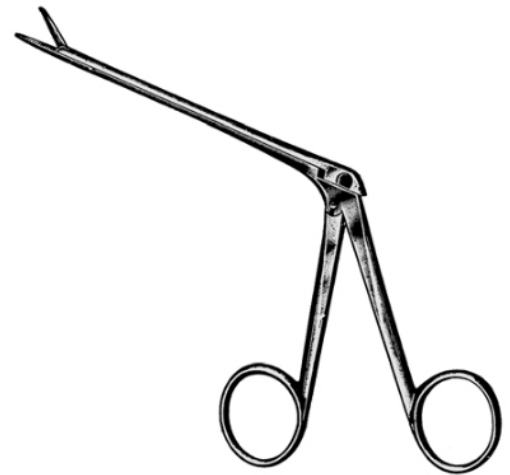

NOYES
JU-22-188-06
 NOYES

Rhinology

NOYES
JU-22-188-07
 NOYES
 14,5,



NOYES
JU-22-188-08
 NOYES
 14,5 cm, 1x2,



BRUENINGS
JU-22-188-09
 BRUENINGS
 19 cm,



BRUENINGS
JU-22-188-10
 BRUENINGS



BRUENINGS
JU-22-188-11
 BRUENINGS

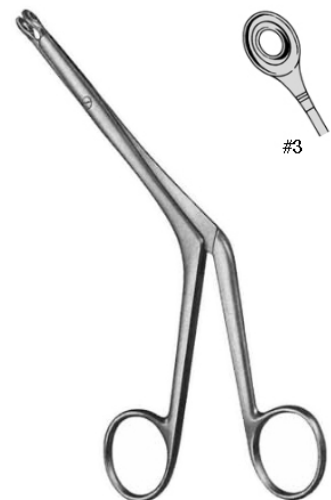

BRUENINGS
JU-22-188-12
 BRUENINGS

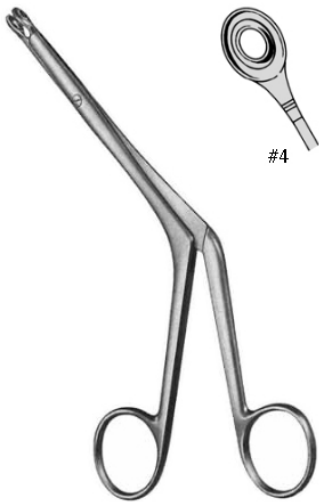
Rhinology

BRUENINGS
JU-22-188-13
 BRUENINGS



HEYMANN
JU-22-188-14
 HEYMANN
 18 cm,



HEYMANN
JU-22-188-15
 HEYMANN

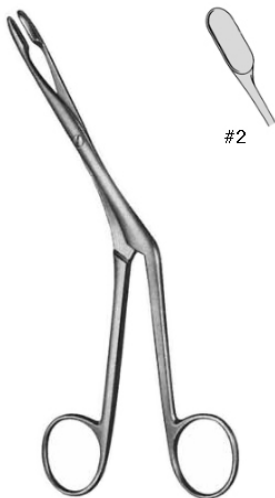

HEYMANN
JU-22-188-16
 HEYMANN

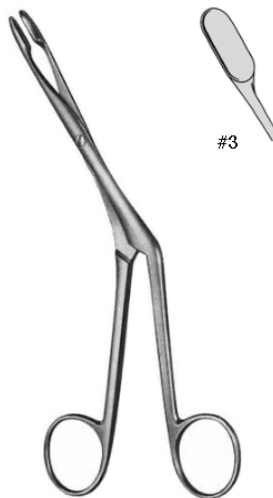

HEYMANN
JU-22-188-17
 HEYMANN

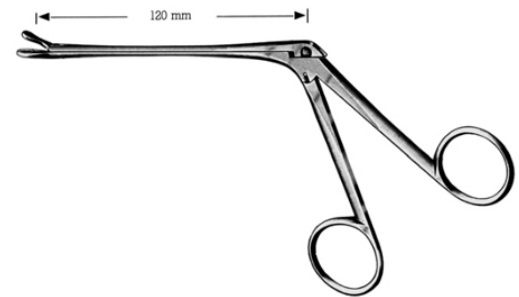

WATSON-WILLIAMS
JU-22-188-18
 WATSON-WILLIAMS
 19 cm,

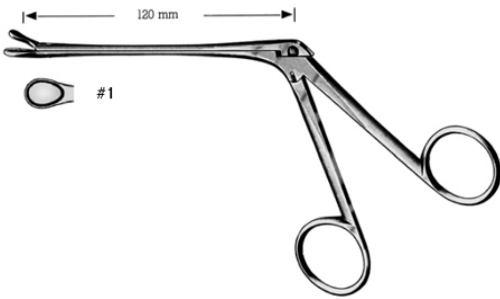
Rhinology

WATSON-WILLIAMS
JU-22-188-19
 WATSON-WILLIAMS

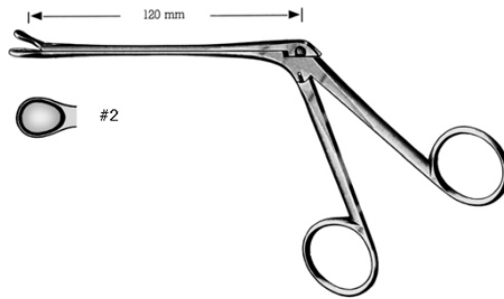

WATSON-WILLIAMS
JU-22-188-20
 WATSON-WILLIAMS

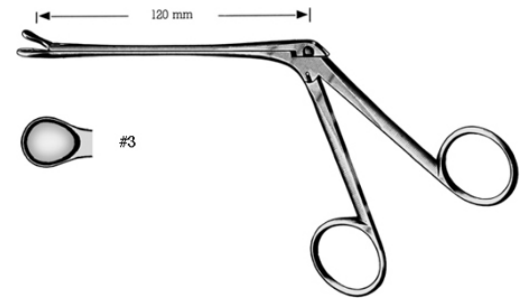

WATSON-WILLIAMS
JU-22-188-21
 WATSON-WILLIAMS

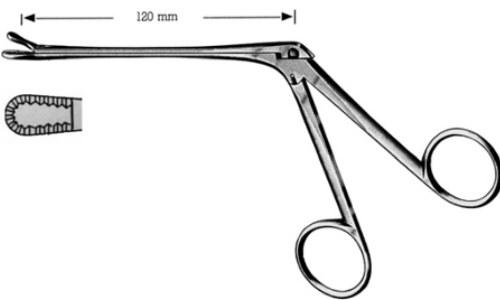

WATSON-WILLIAMS
JU-22-188-22
 WATSON-WILLIAMS

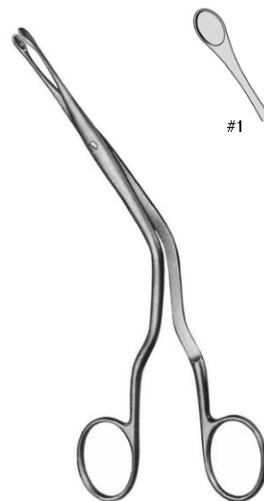

LUC
JU-22-188-23
 LUC
 19 cm,

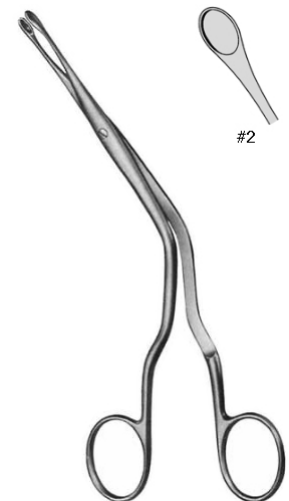

LUC
JU-22-188-24
 LUC
 19 cm,

Rhinology

LUC
JU-22-188-25
 LUC
 19 cm,

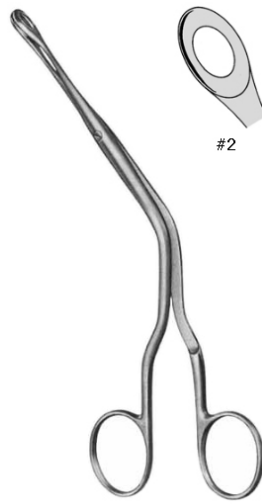

LUC
JU-22-188-26
 LUC
 19 cm,

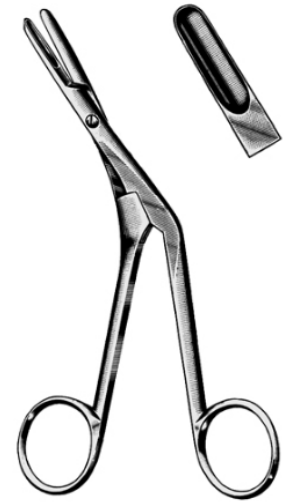

CRAIG
JU-22-188-27
 CRAIG
 18 cm,



CRAIG
JU-22-188-28
 CRAIG
 18 cm,



CRAIG
JU-22-188-29
 CRAIG
 18 cm,

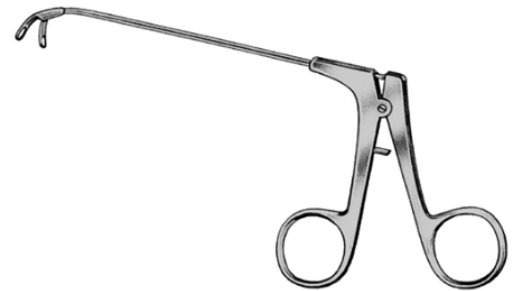

HEUWIESER
JU-22-188-30
 Antrum polypus grasping forceps

Rhinology

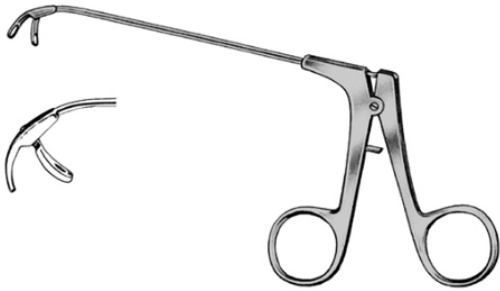

HEUWIESER
JU-22-188-31
down

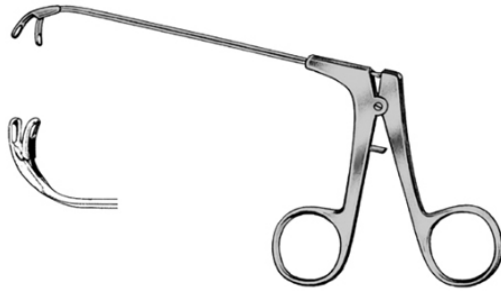

HEUWIESER
JU-22-188-32
up

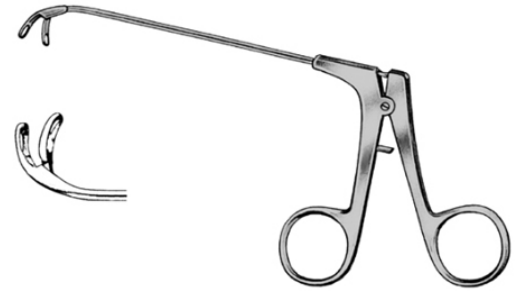

HEUWIESER
JU-22-188-33
right

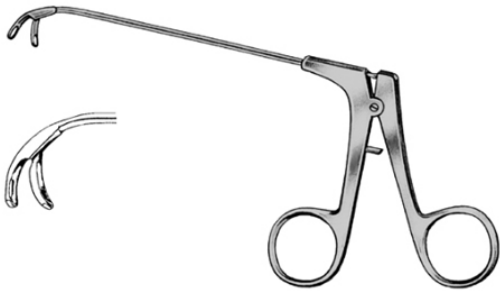

HEUWIESER
JU-22-188-34
left



JANSEN-MIDDLETON
JU-22-188-35
JANSEN-MIDDLETON
19 cm,

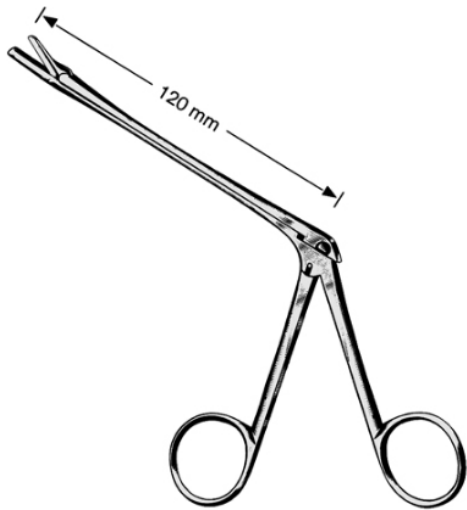

JANSEN-MIDDLETON
JU-22-188-36
JANSEN-MIDDLETON
19 cm,

Rhinology

STRUYCKEN
JU-22-188-37
 STRUYCKEN
 19 cm,



SCHMEDEN
JU-22-188-38
 SCHMEDEN
 11 mm,



STRUYCKEN
JU-22-188-39
 STRUYCKEN



STRUYCKEN
JU-22-188-40
 STRUYCKEN

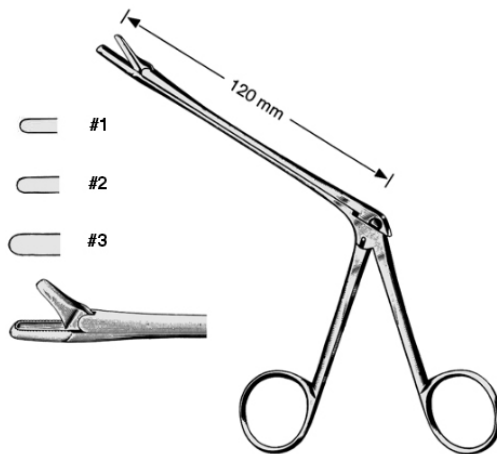

MYLES
JU-22-188-41
 MYLES

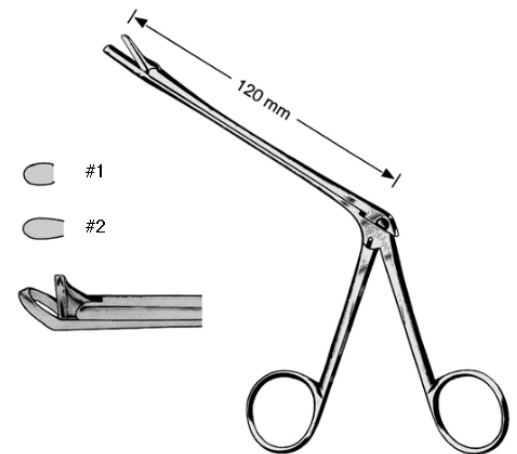

WATSON-WILLIAMS
JU-22-188-42
 WATSON-WILLIAMS
 13 cm,

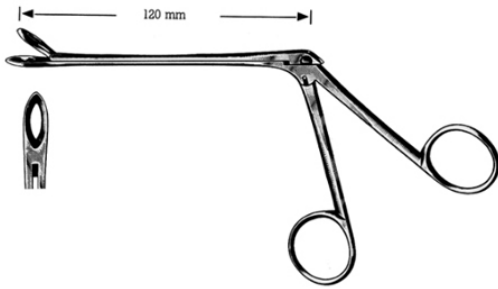

WEIL-BLAKESLEY
JU-22-188-43
 without neck
 19 cm,

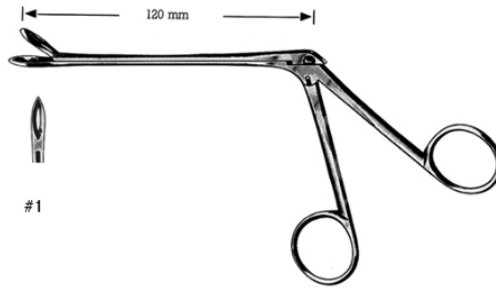

WEIL-BLAKESLEY
JU-22-188-44
 WEIL-BLAKESLEY

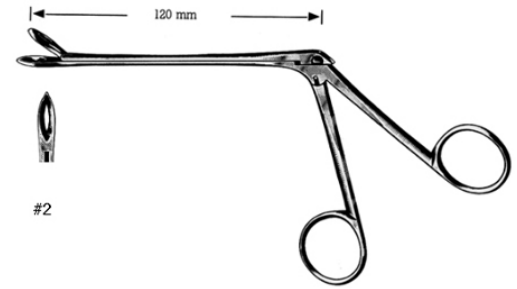

WEIL-BLAKESLEY
JU-22-188-45
 WEIL-BLAKESLEY

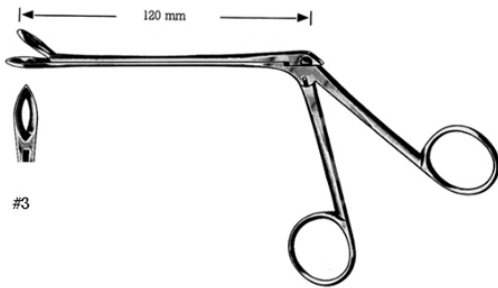

WEIL-BLAKESLEY
JU-22-188-46
 without neck

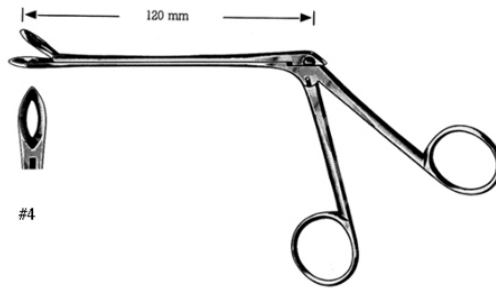

WEIL-BLAKESLEY
JU-22-188-47
 without neck

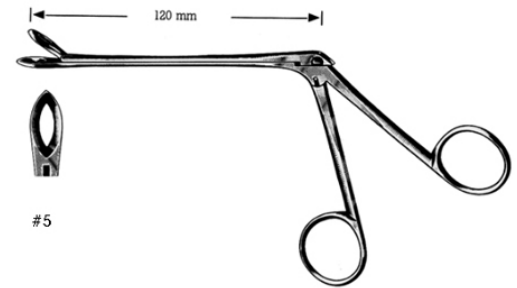

WEIL-BLAKESLEY
JU-22-188-48
 without neck

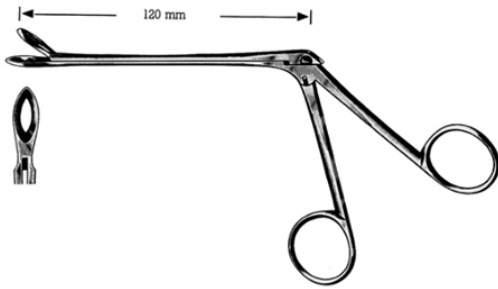

WEIL-BLAKESLEY
JU-22-188-49
 with neck
 19 cm,

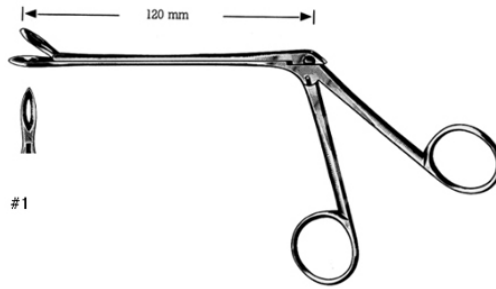

WEIL-BLAKESLEY
JU-22-188-50
 with neck

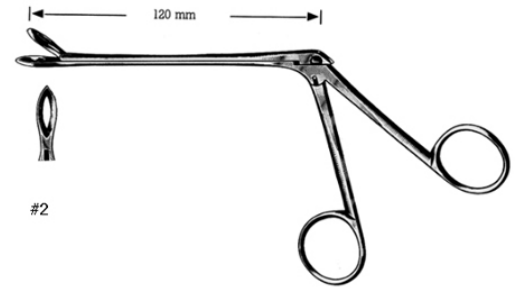

WEIL-BLAKESLEY
JU-22-188-51
 with neck

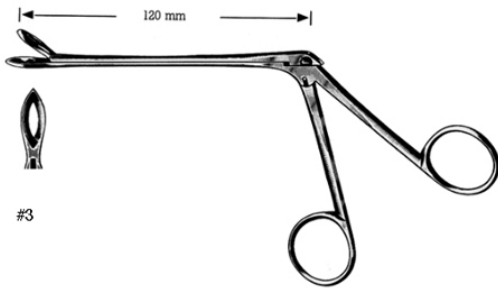

WEIL-BLAKESLEY
JU-22-188-52
 with neck

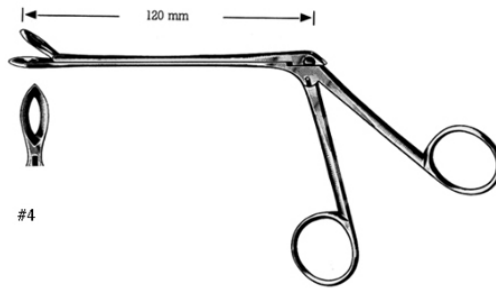

WEIL-BLAKESLEY
JU-22-188-53
 with neck

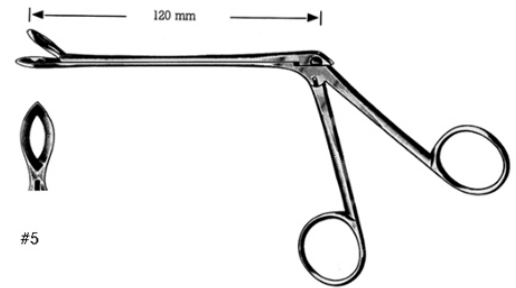

WEIL-BLAKESLEY
JU-22-188-54
 with neck

Rhinology

WEIL-BLAKESLEY
JU-22-188-55
 WEIL-BLAKESLEY
 20 cm,



WEIL-BLAKESLEY
JU-22-188-56
 WEIL-BLAKESLEY
 3,0mm,

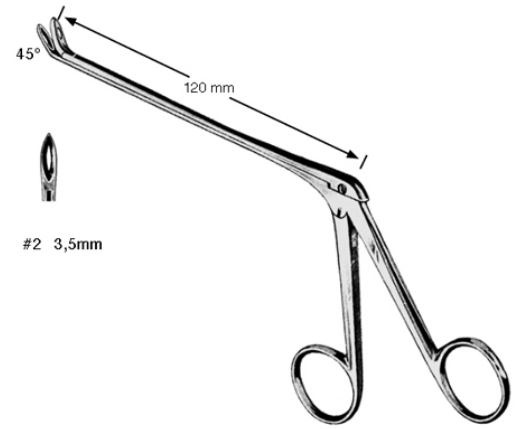

WEIL-BLAKESLEY
JU-22-188-57
 WEIL-BLAKESLEY
 3,5mm,



WEIL-BLAKESLEY
JU-22-188-58
 WEIL-BLAKESLEY
 4,0mm,

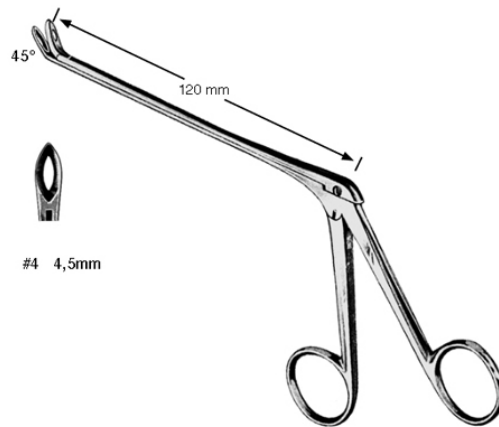

WEIL-BLAKESLEY
JU-22-188-59
 WEIL-BLAKESLEY
 4,5mm,

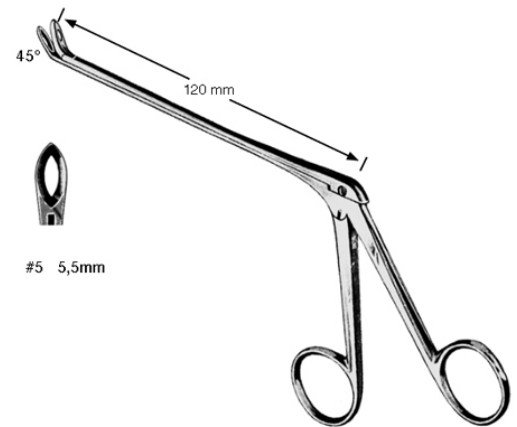

WEIL-BLAKESLEY
JU-22-188-60
 WEIL-BLAKESLEY
 5,5mm,

Rhinology

WEIL-BLAKESLEY
JU-22-188-61
 WEIL-BLAKESLEY

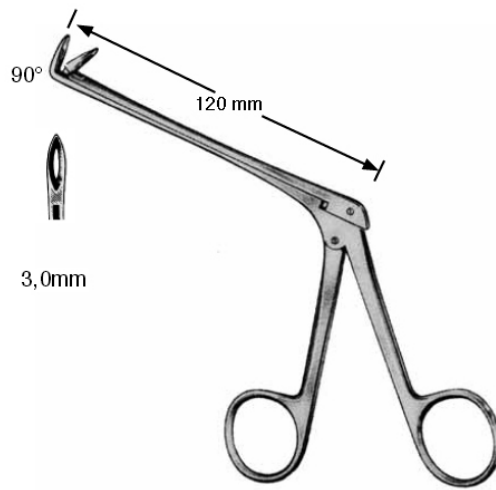

WEIL-BLAKESLEY
JU-22-188-62
 WEIL-BLAKESLEY
 3,0mm,



WEIL-BLAKESLEY
JU-22-188-63
 WEIL-BLAKESLEY
 3,5mm,



WEIL-BLAKESLEY
JU-22-188-64
 WEIL-BLAKESLEY
 4,5mm,



WEIL-BLAKESLEY
JU-22-188-65
 WEIL-BLAKESLEY
 5,0mm,

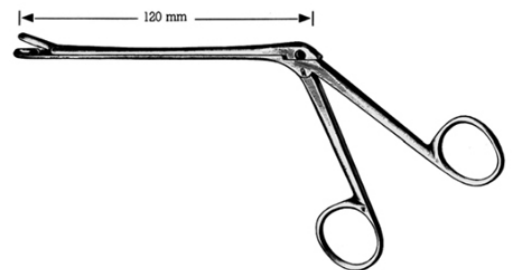

TAKAHASHI
JU-22-188-66
 TAKAHASHI
 19 cm,

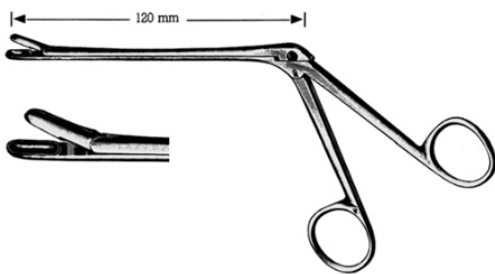
Rhinology

TAKAHASHI
JU-22-188-67
 TAKAHASHI
 2x10 mm, 3x10 mm, 4x10 mm,

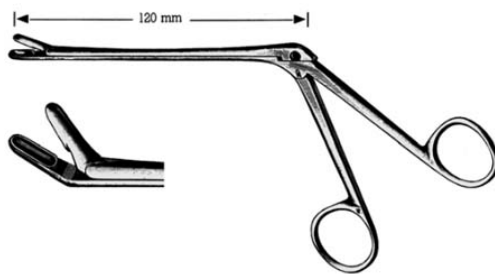

TAKAHASHI
JU-22-188-68
 TAKAHASHI
 2x10 mm, 3x10 mm, 4x10 mm,

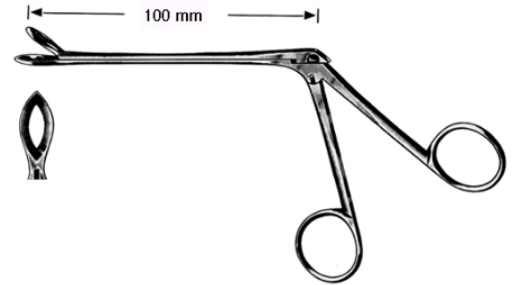

TILLEY-HENCKEL
JU-22-188-69
 TILLEY-HENCKEL
 6,5 mm,



OSTROM
JU-22-188-70
 without illustration: rotating
 100 mm,

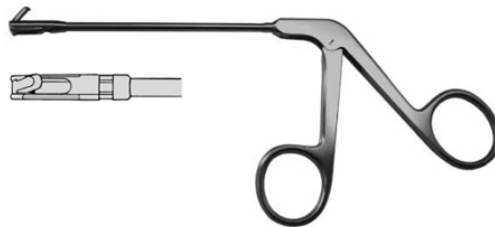

OSTROM
JU-22-188-71
 upside backward cutting

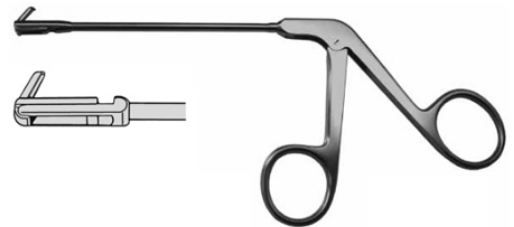

OSTROM
JU-22-188-72
 right side, backward cutting

Rhinology



OSTROM
JU-22-188-73
 left side, backward cutting



HARTMANN
JU-22-188-74
HARTMANN

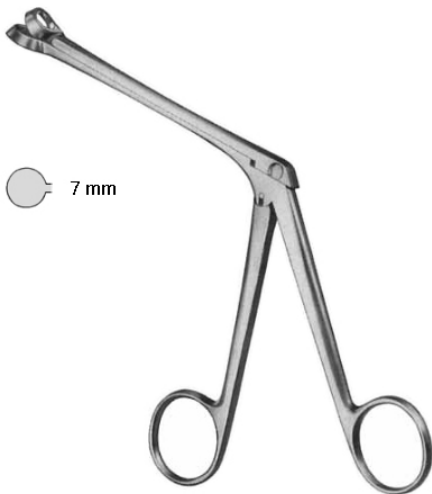

HARTMANN
JU-22-188-75
HARTMANN
 5 mm,



HARTMANN
JU-22-188-76
HARTMANN
 7 mm,

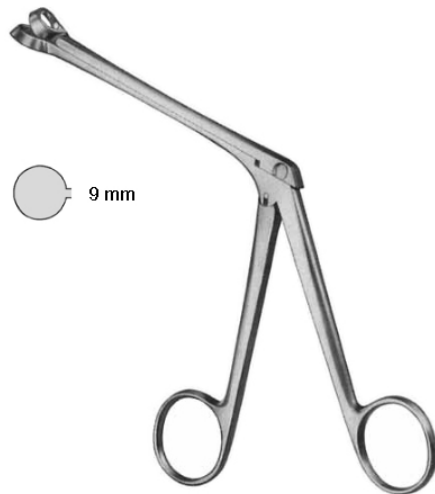

HARTMANN
JU-22-188-77
HARTMANN
 9 mm,

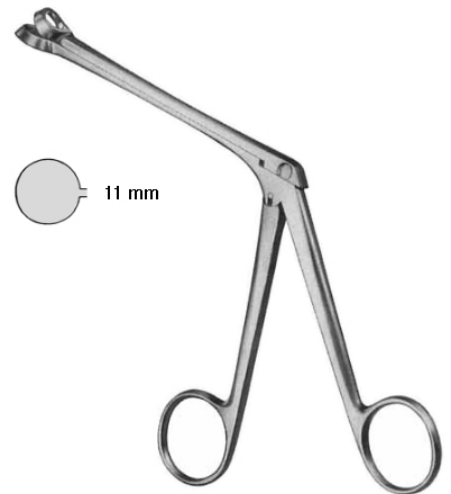

HARTMANN
JU-22-188-78
HARTMANN
 11 mm,

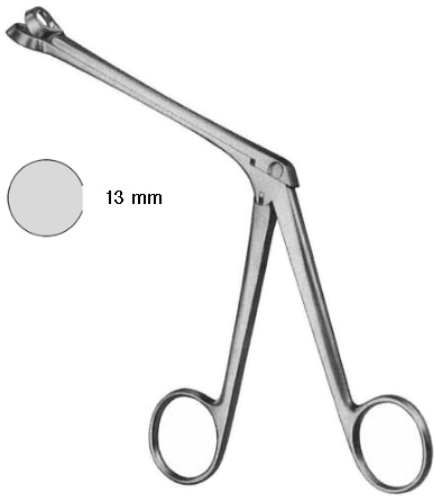
Rhinology

13 mm

HARTMANN
JU-22-188-79
HARTMANN
13 mm,

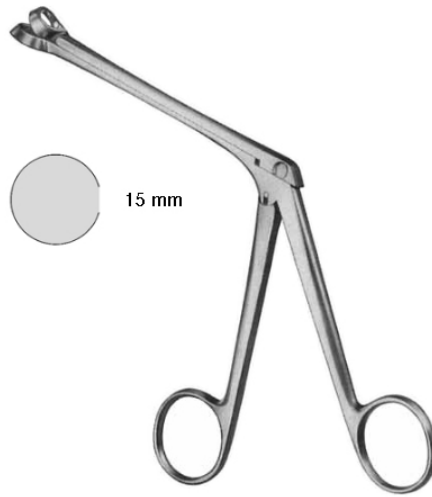

15 mm

HARTMANN
JU-22-188-80
HARTMANN
15 mm,

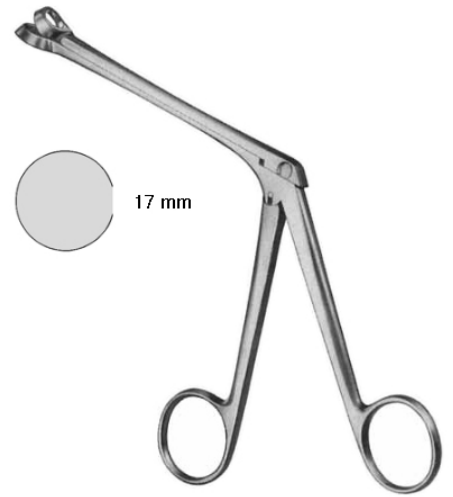

17 mm

HARTMANN
JU-22-188-81
HARTMANN
17 mm,

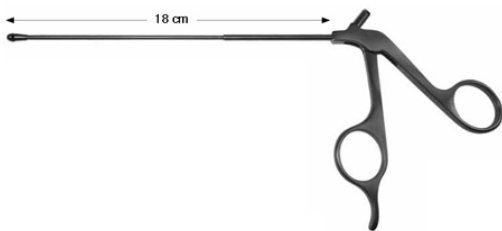

18 cm

STAMMBERGER
JU-22-188-82
STAMMBERGER
27 cm,

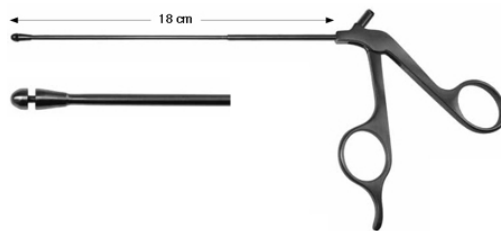

18 cm

STAMMBERGER
JU-22-188-83
straight
Ø 3,5 mm ,

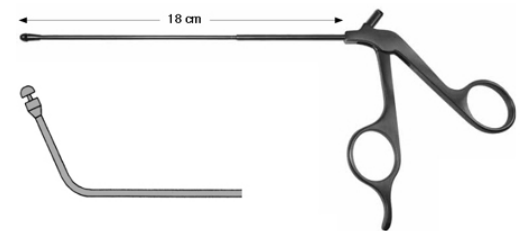

18 cm

STAMMBERGER
JU-22-188-84
up-curved
65° Ø 3,5 mm , 65° Ø 4,5 mm ,

Rhinology

KERRISON
JU-22-188-85

KERRISON
3 mm, 4 mm, 5 mm, 6 mm,



HAJEK-KOFLER
JU-22-188-86

HAJEK-KOFLER



HAJEK-KOFLER
JU-22-188-87

HAJEK-KOFLER
3,5 mm,

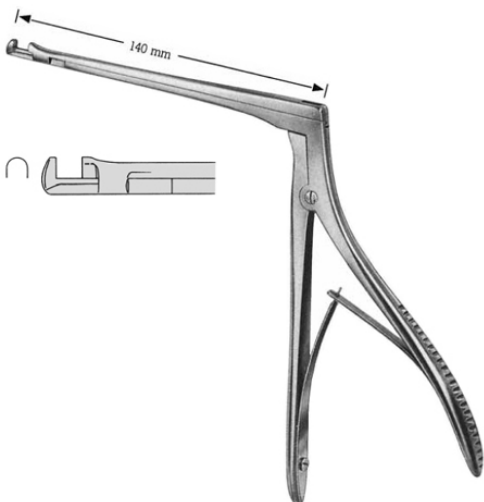

HAJEK-KOFLER
JU-22-188-88

HAJEK-KOFLER
4 mm,

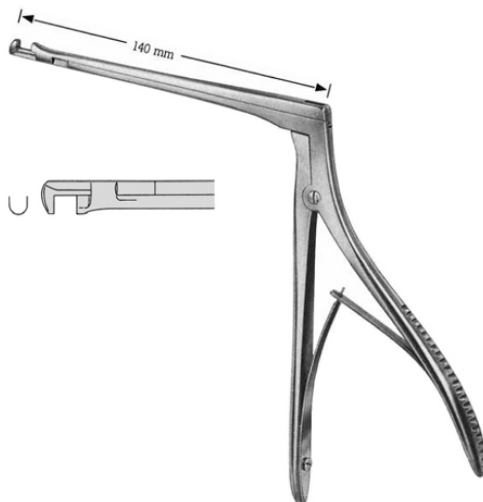

HAJEK-KOFLER
JU-22-188-89

HAJEK-KOFLER
3,5 mm,



HAJEK-KOFLER
JU-22-188-90

HAJEK-KOFLER
4 mm,



HAJEK-CLAUS
JU-22-188-91
HAJEK-CLAUS
20 cm,



CITELLI
JU-22-188-92
CITELLI
5 mm, 2 mm, 3 mm,



BEYER
JU-22-188-93
BEYER
18 cm, 2 mm,



CONTACT US

Jimy Brothor Ins

Address:

339A North High Street MT Vernon
10550, USA

T: 347 469 5700

F: 347 469 5700

PRODUCTS CATALOGUE